



TECHNICAL BROCHURE



OUR COMPANY

The history of Floover began to take shape in 2006 with the union of Andrea Prati and Joan Ferrer, friends and co-owners with extensive experience in the flooring business. Based on the needs and requests of their customers, they developed a new product, Floover, multilayer rigid flooring with designs based on high-end vinyl with the Unilin click system. Later, they developed other versions and incorporated waterproof unlimited designs with remarkable success.

The aim of Floover is the continuous search for new and amazing products always based on the latest design and fashion, intending to improve the quality of life. Innovation and imagination have always been the basis of the brand and are key to its reputation in the market place, involving designers and architects to provide added value to the product. To date, Floover has achieved significant international presence.



OUR PRODUCTS

Floover's production is mainly located in Müstair, Switzerland, where the entire production process complies with Swiss law and with the European norms and standards, in addition to the very strict quality controls.

Floover provides products for both domestic and commercial use, always using new technologies and creating solutions demanded by the market, from gluing systems (Glue Down), through the floor with click system, to exterior solutions. All Floover products are easy to install and are specifically designed for high durability and longevity. All this is complemented with accessories needed to complete any project.

The extensive collection of designs can be installed in any space, including wet areas like bathrooms or terraces, Floover is the ultimate solution to your project.

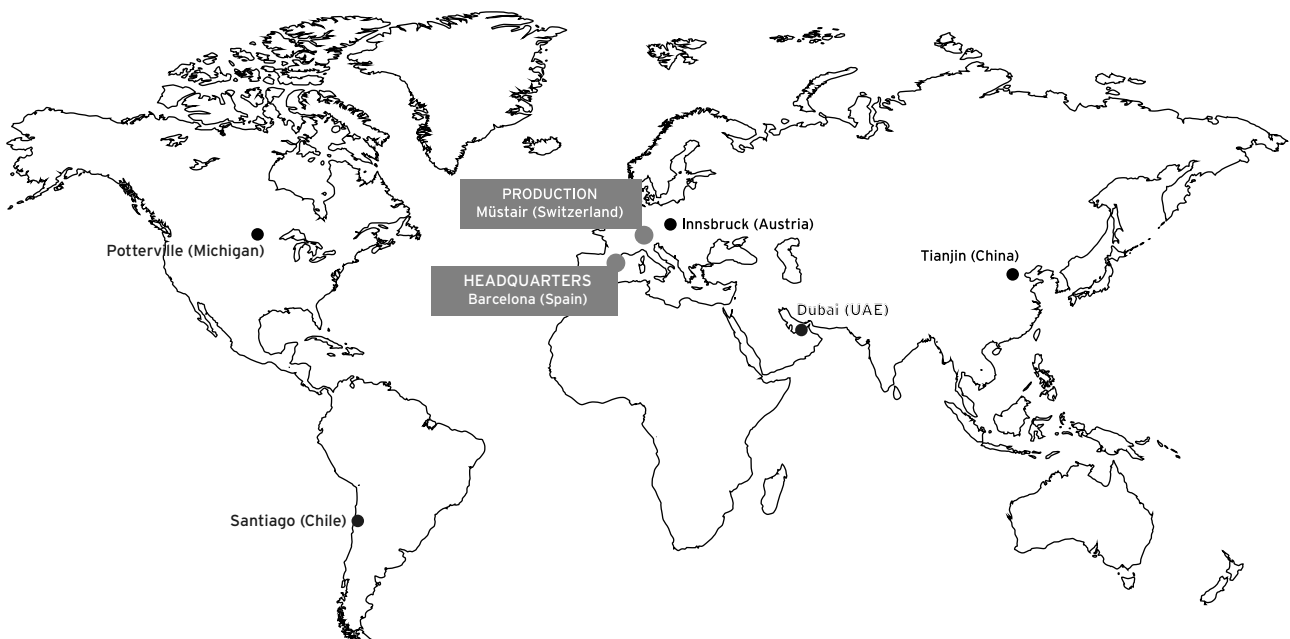

Commercial Office

INDEX

LVT COLLECTION	5
Glue Down.....	8
HDF.....	9
HDF Light.....	9
SplasH ₂ O Light.....	10
SplasH ₂ O Light.....	11
Raised Softcore.....	12
Raised Hardcore.....	13
WOVEN SAMPLES	15
Glue Down.....	16
Loose Lay.....	17
Woven rolls.....	18
HDF.....	19
SplasH ₂ O.....	20
SplasH ₂ O Light.....	21
Decking.....	22
FLOOVER ACCESSORIES	23
Flooverflex.....	23
Skirting.....	24
Stairnose and Transition.....	25
Raised.....	29
Other complements.....	29
INSTALLATION	30
General Installation.....	30
Endless synchro.....	32
Woven Glue Down (roll).....	33
Woven Glue Down (tiles).....	35
Underfloor Heating.....	37
Stairs.....	39
MAINTENANCE	40
Cleaning, Maintenance and Restoration.....	40
FLOOVER	44
Applications and Technology.....	44
Comparative Floover/Laminate.....	45
Comparative Floover SplasH ₂ O / Other products.....	46
FLOOVER WARRANTY	47
FAQ	48

LVT



original
WOOD

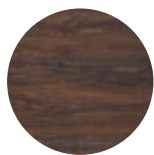

WD1003
Wenge



WD1004
White Grey



WD1005
Jatoba



WD1006
Maple



WD1007
Oak Grey



WD1009
Oak White

Plank size: 915 x 305 mm
Wear Layer Thickness: 0.3 mm

Total Thickness: 1.8 mm
Pattern repeat: 2x2

Coating: PU Coating
Embossing: Wood

original
STONE



CR1102
Ceramic Perla

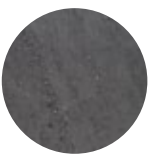

CR1103
Ceramic Antracita



CM1304
Cement Dark



CM1305
Cement Grey



CM1306
Concrete Dark



CM1307
Concrete Light

Plank size: 620 X 450/ 915x305 mm
Wear Layer Thickness: 0.3 mm

Total Thickness: 1.8 mm
Pattern repeat: 2x2

Coating: PU Coating
Embossing: Concrete / Cement / Ceramic

original
LEATHER

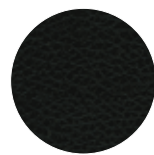

LE1601
Leather Black



LE1602N
Leather Brown



LE1603
Leather Crocodile

Plank size: 620 X 450/ 915x305 mm
Wear Layer Thickness: 0.3 mm

Total Thickness: 1.8 mm
Pattern repeat: 2x2

Coating: PU Coating
Embossing: Leather

original
METALLIC



MT1401
Metallic Silver



MT1404
Metallic Swing

Plank size: 620 X 450/ 915x305 mm
Wear Layer Thickness: 0.3 mm

Total Thickness: 1.8 mm
Pattern repeat: 2x2

Coating: PU Coating
Embossing: Smooth

original
COUNTRY

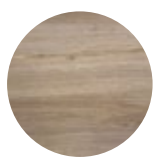

CT1702
Tradition Classic



CT1703
Tradition Lime Washed

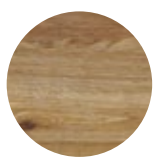

CT1704
Tradition Authentic



CT1706
Rustic Old



CT1707
Rustic Natur



CT1708
Rustic Light

Plank size: 915 x 305 mm
Wear Layer Thickness: 0.3 mm

Total Thickness: 1.8 mm
Different pattern: 2x2 designs

Coating: PU Coating
Embossing: Wood

original
SEQUOIA



SQ1801
Ancient Oak



SQ1805
Oak Limewashed



SQ1806
Aspen Oak



SQ1807
Ash



SQ1808
Barrel Grey

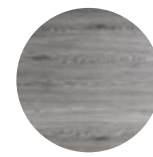

SQ1809
Excelsior Grey

Plank size: 1230 x 225 mm
Wear Layer Thickness: 0.3 mm

Total Thickness: 1.8 mm
Pattern repeat: 4x2

Coating: PU Coating
Embossing: Wood

original
NATURAL



NT1201
White Washed



NT1202
Grey Oak



NT1203
Volcano



NT1204
White Oak



NT1205
Natural Oak

Plank size: 1235 x 230 mm
Wear Layer Thickness: 0.3 mm

Total Thickness: 1.6 mm
Pattern repeat: 8x2

Coating: Super Coating
Embossing: Thin Grain

Loose Lay solution: 5mm

original
URBAN



UB1206
Kensington



UB1207
Chelsea



UB1208
Knightsbridge

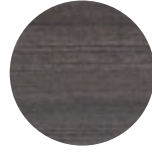

UB1209
Belgravia

Plank size: 1235 x 230 mm
Wear Layer Thickness: 0.3 mm

Total Thickness: 1.6 mm
Pattern repeat: 4x2

Coating: Supercoating
Embossing: Handscrapped

Loose Lay solution: 5mm

original
LUXURY



LX1210
Chesnut



LX1211
Walnut Grey



LX1212
Walnut

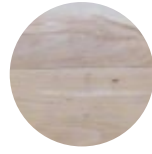

LX1213
Maple

Plank size: 1235 x 230 mm
Wear Layer Thickness: 0.3 mm

Total Thickness: 1.6 mm
Pattern repeat: 4x2

Coating: Super Coating
Embossing: Handscrape
(LX1213: Wood)

Loose Lay solution: 5mm

synchro
RUSTIC

Microbevel 4 sides



SC3001
Rustic Oak Moscow



SC3002
Rustic Oak Stockholm



SC3003
Rustic Oak Zurich



SC3004
Rustic Oak Amsterdam



SC3005
Rustic Oak Berlin



SC3006
Rustic Oak Dublin

Plank size: 1230 x 225 mm
Wear Layer Thickness: 0.55 mm

Total Thickness: 2.0 mm
Pattern repeat: 4x2

Coating: PU Coating
Embossing: Wood synchronized

synchro
PLANK



SC3007
Plank Harmony Dark



SC3008
Plank Harmony Accent



SC3009
Plank Harmony White



SC3010
Plank Harmony Light



SC3011
Plank Harmony Grey



SC3012
Plank Harmony
Classic

Plank size: 1230 x 305 mm
Wear Layer Thickness: 0.55 mm

Total Thickness: 2.0 mm
Pattern repeat: 3x2

Coating: PU Coating
Embossing: Wood synchronized

synchro
ENDLESS

Microbevel 2 long sides



SC3013
Endless Old



SC3014
Endless Antique



SC3015
Endless Real



SC3016
Endless Ice



SC3017
Endless Modern



SC3018
Endless Warm

Plank size: 1230 (x2) x 305 mm
Wear Layer Thickness: 0.55 mm

Total Thickness: 2.0 mm
Pattern repeat: 6x2

Coating: PU Coating Mate
Embossing: Wood synchronized

long
LONGBOARD

Microbevel 4 sides



LB9001
Molokai



LB9002
Gardner



LB9003
Necker



LB9004
Laysan

Plank size: 1815 x 230 mm
Wear Layer Thickness: 0.55 mm

Total Thickness: 2 mm
Pattern repeat: 4x2

Coating: PU Coating
Embossing: Wood

group
PLUS



IRT2005
Iron



IRT2006
Iron Gold



CMT2008
Cement White

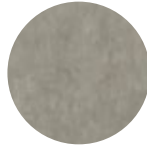

CMT2007
Cement Silver



CRT2104
Black Slate



WDT2001
Wood Wenge



WDT2002
Wood White

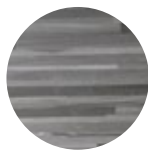

WDT2003
Industrial Grey



WDT2004
Industrial Brown

Plank size: 620 X 450/ 915x305 mm
(WDT2004 1235x305mm)

Wear Layer Thickness: 0.55 mm
Total Thickness: 2 mm
Pattern repeat: 2x2

Coating: PU Coating
Embossing: Smooth/ Wood / Fineline



GLUE DOWN

TECHNICAL DATA SHEET

Floover Glue Down consists of 3 layers. The top layer is a resistant transparent PVC to protect the decor. This adapts perfectly to the elasticity of the vinyl below creating a nice walking surface. The traditional gluing system allows you to install large areas with a small thickness. High traffic, comfort and acoustic performance. Available in every reference



- ① Layer of transparent PVC
- 0,3 mm Original
- 0,55 mm Synchro and Plus

② Decor

③ Vinyl

Characteristics	Test	Glue Down Original	Glue Down Synchro	Glue Down Plus
Classification	EN 685	23/32	23/33	23/33
Dimensions	EN 427	915 x 305 mm 620 x 450 mm (CM,CR,MT,LE) 1230 X 225 mm (SQ) 1235 x 230 mm (NT, UB, LX)	1230 x 225 mm (Rustic) 1230 x 305 mm (Plank + Endless) 1815 x 230 mm (Longboard)	915 x 305 mm 1235x305 mm (WDT2004) 620x450 (CMT,IRT,CRT)
Thickness	EN 430	1,8 mm	2,0 mm	2,0 mm
Weight	EN 430	3,15 - 3,44 kg/m ²	3,41 - 3,63 kg/m ²	4,13 kg/m ²
Abrasion resistance	EN 660-1: 99	0,068 mm	0,068 mm	0,068 mm
	EN 660-2: 99	1,80 mm ³	1,80 mm ³	1,80 mm ³
Chemical resistance	En 423	Class 0	Class 0	Class 0
Fire resistance	EN 13501-1	Class BFLs1 (B1)	Class BFLs1 (B1)	Class BFLs1 (B1)
UV Resistance	ISO 105	≥ Grade 6	≥ Grade 6	≥ Grade 6
Fungus test	ASTM G21:96	Grade 1	Grade 1	Grade 1
Antistatic Performance	EN 1815	0,63 kv	0,63 kv	0,63 kv
Water Resistant test	EN 317	0% Swelling	0% Swelling	0% Swelling
Slip resistance	EN12633	Class 2	Class 2	Class 2



Fire Resistant



Ecological



Abrasion Resistant



Antistatic



Chemical Resistant



Silent



UV Ray Resistant



Impact Resistant



Waterproof

HDF

TECHNICAL DATA SHEET

Floover HDF consists of 5 layers. The top layer is a resistant transparent PVC to protect the decor. This adapts perfectly to the elasticity of the vinyl below creating a nice walking surface. The fourth layer of HDF incorporates the clic installation system. The ultimate layer of cork gives an excellent thermal and acoustic insulation.



- ① Layer of transparent PVC
- 0,3 mm Original
- 0,55 mm Synchro and Plus
- ② Printed Decor
- ③ Vinyl
- ④ HDF 6,8 mm
- ⑤ Cork 1,2 mm

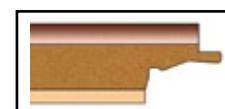
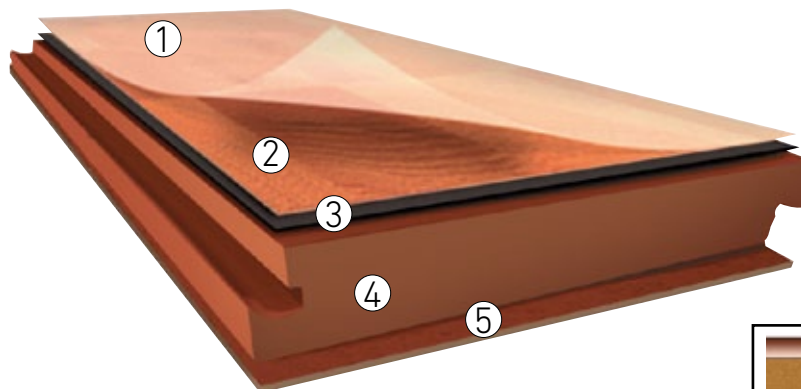

EP2246188A1 Patent Floover

Characteristics	Test	HDF Original	HDF Synchro	HDF Plus
Classification	EN 685	23 / 32	23 / 33	23 / 33
Dimensions	EN 427	915 x 305 mm 620 x 450 mm (CM,CR,MT,LE) 1230 X 225 mm (SQ) 1235 x 230 mm (NT, UB, LX)	1230 x 225 mm (Rustic) 1230 x 305 mm (Plank + Endless) 1815 x 230 mm (Longboard)	915 x 305 mm 1235x305 mm (WDT2004) 620x450 (CMT,IRT,CRT)
Thickness	EN 428	9,8 mm	10 mm	10 mm
Weight	EN 430	10,15 Kg/m ²	10,30 Kg/m ²	11,10 Kg/m ²
Abrasion resistance	EN 660-1: 99	0,068 mm	0,068 mm	0,068 mm
	EN 660 -2: 99	1,80 mm ³	1,80 mm ³	1,80 mm ³
Fire resistance	EN 13501-1	Class BFLs1 (B1)	Class BFLs1 (B1)	Class BFLs1 (B1)
Stain resistance	EN 438	Grade 5 (Groups 1 and 2) and Grade 4 (Group 3)	Grade 5 (Groups 1 and 2) and Grade 4 (Group 3)	Grade 5(Groups 1 and 2) and Grade 4 (Group 3)
Dimensional stability	EN 434	- 0,01 %	- 0,01 %	- 0,01 %
Curving	EN 434	0,2 mm	0,2 mm	0,2 mm
Acoustic certification	EN 140	ΔLw= 18dB	ΔLw= 18dB	ΔLw= 18 dB
Cigarette burn resistance	EN 438 - 2	Class 3	Class 3	Class 3
Impact resistance	EN 1534	7,4 Kgf/mm ²	7,4 Kgf/mm ²	7,4 Kgf/mm ²
Slip/Slide resistance	EN 12633	Class 2	Class 2	Class 2
Flexibility	EN 435	10 mm	10 mm	10 mm
UV Resistance	ISO 105	≥ Grade 6	≥ Grade 6	≥ Grade 6
Formaldehyde emission	EN 717	E1	E1	E1
Thermal resistance	EN 12664	0,088 m ² K/W	0,088 m ² K/W	0,088 m ² K/W
Antistatic Performance	EN 1815	0,63 kv	0,63 kv	0,63 kv



Fire Resistance



Ecological



Abrasion resistance



Antistatic



Resistant to chemicals



Acoustic resistance



U.V. resistance



No Glue Installation System



Impact Resistant



Produced under license of Unilin. EP no. 0843743,51,5, patent no. 4.006.488

It's possible to lay 200m² without expansion joints. Maximum length 18 meters.

HDF LIGHT

TECHNICAL DATA SHEET

Floover HDF Light consists of 5 layers. The top layer is a resistant transparent PVC to protect the decor. This adapts perfectly to the elasticity of the vinyl below creating a nice walking surface. The fourth layer of HDF incorporates the clic installation system. The ultimate layer of cork gives an excellent thermal and acoustic insulation.

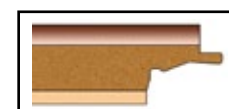
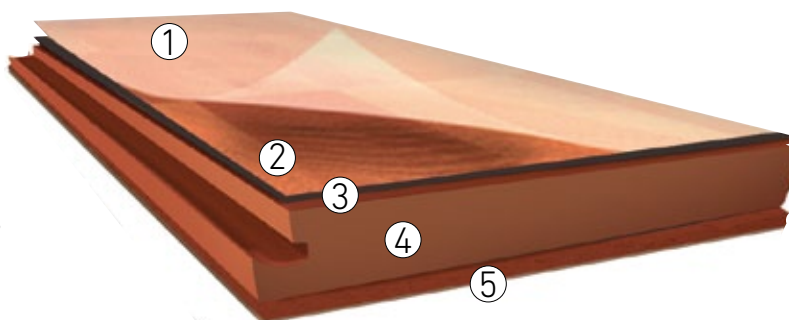

EP2246188A1 Patent Floover

- ① Layer of transparent PVC
- **0,3 mm Original**
- **0,55 mm Synchro and Plus**
- ② Printed Decor
- ③ Vinyl
- ④ HDF 4 mm
- ⑤ Cork 1,2 mm

Characteristics	Test	HDF Original	HDF Synchro	HDF Plus
Classification	EN 685	23 / 32	23 / 33	23 / 33
Dimensions	EN 427	915 x 305 mm 620 x 450 mm (CM,CR,MT,LE) 1230 X 225 mm (SQ) 1235 x 230 mm (NT, UB, LX)	1230 x 225 mm (Rustic) 1230 x 305 mm (Plank + Endless) 1815 x 230 mm (Longboard)	915 x 305 mm 1235x305 mm (WDT2004) 620x450 (CMT,IRT,CRT)
Thickness	EN 428	7 mm	7,2 mm	7,2 mm
Weight	EN 430	9,15 Kg/m ²	9,30 Kg/m ²	10,10 Kg/m ²
Abrasion resistance	EN 660-1: 99	0,068 mm	0,068 mm	0,068 mm
	EN 660 -2: 99	1,80 mm ³	1,80 mm ³	1,80 mm ³
Fire resistance	EN 13501-1	Class BFLs1 (B1)	Class BFLs1 (B1)	Class BFLs1 (B1)
Stain resistance	EN 438	Grade 5 (Groups 1 and 2) and Grade 4 (Group 3)	Grade 5 (Groups 1 and 2) and Grade 4 (Group 3)	Grade 5(Groups 1 and 2) and Grade 4 (Group 3)
Dimensional stability	EN 434	- 0,01 %	- 0,01 %	- 0,01 %
Curving	EN 434	0,2 mm	0,2 mm	0,2 mm
Acoustic certification	EN 140	ΔLw= 20dB	ΔLw= 20dB	ΔLw= 20 dB
Cigarette burn resistance	EN 438 - 2	Class 3	Class 3	Class 3
Impact resistance	EN 1534	7,4 Kg/mm ²	7,4 Kg/mm ²	7,4 Kg/mm ²
Slip/Slide resistance	EN 12633	Class 2	Class 2	Class 2
Flexibility	EN 435	10 mm	10 mm	10 mm
UV Resistance	ISO 105	≥ Grade 6	≥ Grade 6	≥ Grade 6
Formaldehyde emission	EN 717	E1	E1	E1
Thermal resistance	EN 12664	0.075 m ² K/W	0.075 m ² K/W	0.075 m ² K/W
Antistatic Performance	EN 1815	0,63 kv	0,63 kv	0,63 kv
HDF Swelling Value	EN 313	< 4%	< 4%	< 4%



Fire Resistance



Ecological



Abrasion resistance



Antistatic



Resistant to chemicals



Acoustic resistance



U.V. resistance



No Glue Installation System



Impact Resistant



Produced under license of Uniclic - EP n. 0803763/0,1,1,2,3,4,5,6,7,8,9,10,11,12,13,14,15,16,17,18,19,20,21,22,23,24,25,26,27,28,29,30,31,32,33,34,35,36,37,38,39,40,41,42,43,44,45,46,47,48,49,50,51,52,53,54,55,56,57,58,59,60,61,62,63,64,65,66,67,68,69,70,71,72,73,74,75,76,77,78,79,80,81,82,83,84,85,86,87,88,89,90,91,92,93,94,95,96,97,98,99,100,101,102,103,104,105,106,107,108,109,110,111,112,113,114,115,116,117,118,119,120,121,122,123,124,125,126,127,128,129,130,131,132,133,134,135,136,137,138,139,140,141,142,143,144,145,146,147,148,149,150,151,152,153,154,155,156,157,158,159,160,161,162,163,164,165,166,167,168,169,170,171,172,173,174,175,176,177,178,179,180,181,182,183,184,185,186,187,188,189,190,191,192,193,194,195,196,197,198,199,200,201,202,203,204,205,206,207,208,209,210,211,212,213,214,215,216,217,218,219,220,221,222,223,224,225,226,227,228,229,230,231,232,233,234,235,236,237,238,239,240,241,242,243,244,245,246,247,248,249,250,251,252,253,254,255,256,257,258,259,260,261,262,263,264,265,266,267,268,269,270,271,272,273,274,275,276,277,278,279,280,281,282,283,284,285,286,287,288,289,290,291,292,293,294,295,296,297,298,299,300,301,302,303,304,305,306,307,308,309,310,311,312,313,314,315,316,317,318,319,320,321,322,323,324,325,326,327,328,329,330,331,332,333,334,335,336,337,338,339,340,341,342,343,344,345,346,347,348,349,350,351,352,353,354,355,356,357,358,359,360,361,362,363,364,365,366,367,368,369,370,371,372,373,374,375,376,377,378,379,380,381,382,383,384,385,386,387,388,389,390,391,392,393,394,395,396,397,398,399,400,401,402,403,404,405,406,407,408,409,410,411,412,413,414,415,416,417,418,419,420,421,422,423,424,425,426,427,428,429,430,431,432,433,434,435,436,437,438,439,440,441,442,443,444,445,446,447,448,449,450,451,452,453,454,455,456,457,458,459,460,461,462,463,464,465,466,467,468,469,470,471,472,473,474,475,476,477,478,479,480,481,482,483,484,485,486,487,488,489,490,491,492,493,494,495,496,497,498,499,500,501,502,503,504,505,506,507,508,509,510,511,512,513,514,515,516,517,518,519,520,521,522,523,524,525,526,527,528,529,530,531,532,533,534,535,536,537,538,539,540,541,542,543,544,545,546,547,548,549,550,551,552,553,554,555,556,557,558,559,560,561,562,563,564,565,566,567,568,569,570,571,572,573,574,575,576,577,578,579,580,581,582,583,584,585,586,587,588,589,590,591,592,593,594,595,596,597,598,599,600,601,602,603,604,605,606,607,608,609,610,611,612,613,614,615,616,617,618,619,620,621,622,623,624,625,626,627,628,629,630,631,632,633,634,635,636,637,638,639,640,641,642,643,644,645,646,647,648,649,650,651,652,653,654,655,656,657,658,659,660,661,662,663,664,665,666,667,668,669,670,671,672,673,674,675,676,677,678,679,680,681,682,683,684,685,686,687,688,689,690,691,692,693,694,695,696,697,698,699,700,701,702,703,704,705,706,707,708,709,710,711,712,713,714,715,716,717,718,719,720,721,722,723,724,725,726,727,728,729,730,731,732,733,734,735,736,737,738,739,740,741,742,743,744,745,746,747,748,749,750,751,752,753,754,755,756,757,758,759,760,761,762,763,764,765,766,767,768,769,770,771,772,773,774,775,776,777,778,779,780,781,782,783,784,785,786,787,788,789,790,791,792,793,794,795,796,797,798,799,800,801,802,803,804,805,806,807,808,809,810,811,812,813,814,815,816,817,818,819,820,821,822,823,824,825,826,827,828,829,830,831,832,833,834,835,836,837,838,839,840,841,842,843,844,845,846,847,848,849,850,851,852,853,854,855,856,857,858,859,860,861,862,863,864,865,866,867,868,869,870,871,872,873,874,875,876,877,878,879,880,881,882,883,884,885,886,887,888,889,890,891,892,893,894,895,896,897,898,899,900,901,902,903,904,905,906,907,908,909,910,911,912,913,914,915,916,917,918,919,920,921,922,923,924,925,926,927,928,929,930,931,932,933,934,935,936,937,938,939,940,941,942,943,944,945,946,947,948,949,950,951,952,953,954,955,956,957,958,959,960,961,962,963,964,965,966,967,968,969,970,971,972,973,974,975,976,977,978,979,980,981,982,983,984,985,986,987,988,989,990,991,992,993,994,995,996,997,998,999,1000

It's possible to lay 100m² without expansion joints. Maximum length 10 meters.

SPLASH₂0

TECHNICAL DATA SHEET

Floover SplasH₂O is a revolutionary product which is made of 4 layers. The top layer is a high resistance transparent PVC. The following is the decor imprinted onto a layer of compact vinyl. The final layer is a composition of rigid high density PVC, produced by extrusion and 100% waterproof. It is also possible to add a 1.5 mm foam layer **Flooverflex** to reinforce the acoustic and thermal insulation of the product. This product is available in all our decors and designs.



Connect Floover Splash with Floover HDF, with the Unilin clic, but you have to supplement with a 1,5 mm base to compensate for the height difference.



- ① Layer of transparent PVC
- 0,3 mm Original
- 0,55 mm Synchro and Plus
- ② Decor
- ③ Vinyl
- ④ PVC Rigid 6,5 mm
- ⑤ Foam 1,5mm (Optional)

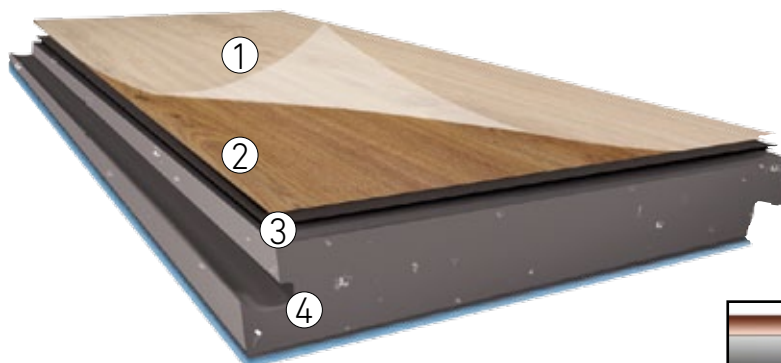

EP2246188A1 Patent Floover

Characteristics	Test	SplasH ₂ O Original	SplasH ₂ O Synchro	SplasH ₂ O Plus
Classification	EN 685	23 / 32	23 / 33	23 / 33
Dimensions	EN 427	915 x 305 mm 620 x 450 mm (CM,CR,MT,LE) 1230 x 225 mm (SQ) 1235 x 230 mm (NT, UB, LX)	1230 x 225 mm (Rustic) 1230 x 305 mm (Plank + Endless)	915 x 305 mm 1235x305 mm (WDT2004) 620x450 (CMT,IRT,CRT)
Thickness	EN 430	8,3 mm	8,5 mm	8,5 mm
Weight	EN 430	10,99 - 12,44 Kg/m ²	11,11 - 11,96 Kg/m ²	12,18 - 12,20 Kg/m ²
Abrasion Resistance	EN 660-1: 99	0,068 mm	0,068 mm	0,068 mm
	EN 660 -2: 99	1,80 mm ³	1,80 mm ³	1,80 mm ³
Fire Resistance	EN 13501-1	Class BFLs1 (B1)	Class BFLs1 (B1)	Class BFLs1 (B1)
Stain Resistance	EN 438	Grade 5 (Groups 1 and 2) and Grade 4 (Group 3)	Grade 5 (Groups 1 and 2) and Grade 4 (Group 3)	Grade 5 (Groups 1 and 2) and Grade 4 (Group 3)
Dimensional Stability	EN 434	- 0,01 %	- 0,01 %	- 0,01 %
Curving	EN 434	0,2 mm	0,2 mm	0,2 mm
Acoustic Certification	EN 140	ΔLw= 20dB	ΔLw= 20dB	ΔLw= 20dB
Cigarette burn resistance	EN 438 - 2	Class 3	Class 3	Class 3
Impact resistance	EN 1534	7,4 Kgf/mm ²	7,4 Kgf/mm ²	7,4 Kgf/mm ²
Slip/Slide resistance	EN 12633	Class 2	Class 2	Class 2
Flexibility	EN 435	10 mm	10 mm	10 mm
UV Resistance	ISO 105	≥ Grade 6	≥ Grade 6	≥ Grade 6
Formaldehyde emission	EN 717	E0	E0	E0
Water Resistant test	EN 317	0% Swelling	0% Swelling	0% Swelling
Thermal resistance	EN 12664	0,088 m ² K/W	0,088 m ² K/W	0,088 m ² K/W
Locking Strength	ISO 24334	> 600 kg/ml	> 600 kg/ml	> 600 kg/ml
Antistatic Performance	EN 1815	0,63 kv	0,63 kv	0,63 kv



Fire Resistant



Ecological



Abrasion Resistant



Antistatic



Chemical Resistant



Silent



UV Ray Resistant



No Glue Installation System



Impact Resistant



Waterproof



Produced under license of Unilin. EP n. 0833703/AU.5. patente n. 0.000.480

It's possible to lay 400m² without expansion joints. Maximum length 20 meters.

SPLASH₂O LIGHT

TECHNICAL DATA SHEET

Floover Splash₂O Light also is 100% waterproof and has the exact composition as the Splash range, however this product has a thinner layer of rigid PVC. Also we have the option to add a 1.5 mm foam base of **Floover-flex** to reinforce the acoustic and thermal insulation and therefore avoid using levelers before installation. All of this is combined with the clic system guaranteeing resistance until 450 kg/ml. Available in every reference



- ① Layer of transparent PVC
- 0,3 mm Original
- 0,55 mm Synchro and Plus
- ② Decor
- ③ Vinyl
- ④ PVC Rigid 3,2 mm
- ⑤ Foam 1,5mm (Optional)

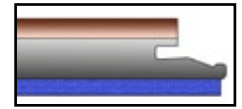

EP2246188A1 Patent Floover

Characteristics	Test	Splash ₂ O light Original	Splash ₂ O light Synchro	Splash ₂ O light Plus
Classification	EN 685	23 / 32	23 / 33	23 / 33
Dimensions	EN 427	915 x 305 mm 620 x 450 mm (CM,CR,MT,LE) 1230 X 225 mm (SQ) 1235 x 230 mm (NT, UB, LX)	1230 x 225 mm (Rustic) 1230 x 305 mm (Plank + Endless)	915 x 305 mm 1235x305 mm (WDT2004) 620x450 (CMT,IRT,CRT)
Thickness	EN 430	5 mm	5,2 mm	5,2 mm
Weight	EN 430	6,78 - 7,55 Kg/m ²	7,63 - 7,96 Kg/m ²	7,88 - 7,98 Kg/m ²
Abrasion Resistance	EN 660-1: 99	0,068 mm	0,068 mm	0,068 mm
	EN 660 -2: 99	1,80 mm ³	1,80 mm ³	1,80 mm ³
Fire Resistance	EN 13501-1	Class BFLs1 (B1)	Class BFLs1 (B1)	Class BFLs1 (B1)
Stain Resistance	EN 438	Grade 5 (Groups 1 and 2) and Grade 4 (Group 3)	Grade 5 (Groups 1 and 2) and Grade 4 (Group 3)	Grade 5 (Groups 1 and 2) and Grade 4 (Group 3)
Dimensional Stability	EN 434	- 0,03 %	- 0,03 %	- 0,03 %
Curving	EN 434	0,5 mm	0,5 mm	0,5 mm
Acoustic Certification	EN 140	ΔLw= 18 dB	ΔLw= 18 dB	ΔLw= 18 dB
Cigarette burn resistance	EN 438 - 2	Class 3	Class 3	Class 3
Impact resistance	EN 1534	7,4 Kgf/mm ²	7,4 Kgf/mm ²	7,4 Kgf/mm ²
Slip/Slide resistance	EN 12633	Class 2	Class 2	Class 2
Flexibility	EN 435	10 mm	10 mm	10 mm
UV Resistance	ISO 105	≥ Grade 6	≥ Grade 6	≥ Grade 6
Formaldehyde emission	EN 717	E0	E0	E0
Water Resistant test	EN 317	0% Swelling	0% Swelling	0% Swelling
Thermal resistance	EN 12664	0,070 m ² K/W	0,070 m ² K/W	0,070 m ² K/W
Locking Strength	ISO 24334	> 500 kg/ml	> 500 kg/ml	> 500 kg/ml
Antistatic Performance	EN 1815	0,63 kv	0,63 kv	0,63 kv

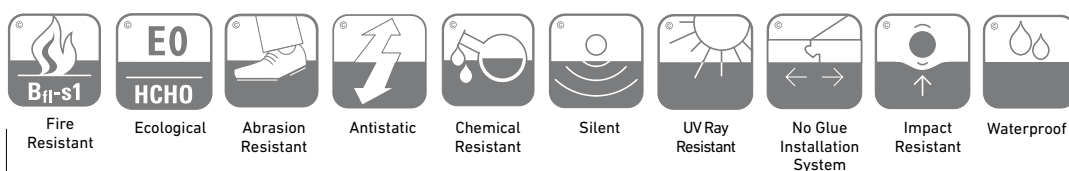

It's possible to lay 200m² without expansion joints. Maximum length 18 meters.

RAISED

TECHNICAL DATA SHEET

Floover Raised is a solution ideal for offices, museums or large areas where no prework for the subfloor or no soil preparation is needed. Intended particularly for workplaces, offices or technical areas where there is lots of cabling, pipes and other connections to be installed. Available for every Floover decor, Antistatic, durable, silent, antibacterial and warm.



RAISED SOFTCORE



- ① Top Layer: PVC
- ② Core: High density chipboard. Thickness 38 mm
- ③ Bottom Layer: Aluminium foil

RAISED HARDCORE

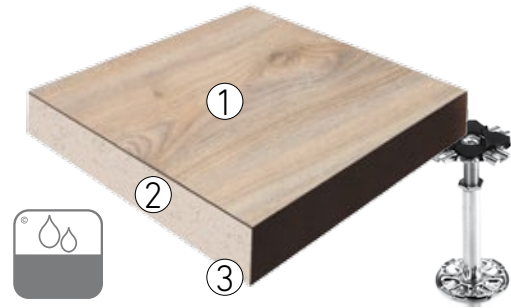

Waterproof

- ① Top Layer: PVC
- ② Core: Calcium Sulphate. Thickness 30 mm
- ③ Bottom Layer: Aluminium foil

Characteristics		Test	Floover Raised SoftCore	Floover Raised Hardcore
CORE	Dimensions		600x600 / 600x900 / 600x1200 mm	600x600 / 600x900 / 600x1200 mm
	Tile thickness (without top layer)		38 mm	30 mm
	Chipboard density		700 kg/m ³	1450 kg/m ³
	Tile weight		26,7 kg/m ²	54 kg/m ²
	Concentrated load with pedestals, without structure		2 KN	4 KN
	Concentrated load with pedestals and Standard beams		3 KN	9 KN
	Concentrated load with pedestals and Heavy beams		4,5 KN	-
	Fire resistance		Cfl-S1	Bfl-S1
	Formaldehyde emission	EN312-1	E1	E1
	Thermal Conductivity		2,4 w/ m ² °C	3,5 w/ m ² °C
Acoustic Insulation RLWP		≥ 50 dB	≥ 45 dB	

LVT TOP LAYER	Abrasion resistance	EN 660-1: 99	0,068 mm
		EN 660-2: 99	1,80 mm ³
	Chemical resistance	En 423	Class 0
	Fire resistance	EN 13501-1	Class BFLs1 (B1)
	UV Resistance	ISO 105	≥ Grade 6
	Fungus test	ASTM G21:96	Grade 1
	Slip/Slide resistance	EN 12633	Class 2



Fire Resistance



Ecological



Abrasion resistance



Antistatic



Resistant to chemicals



Acoustic resistance



U.V. resistance



Impact Resistant



WOVEN



WV4001
Bold Grey

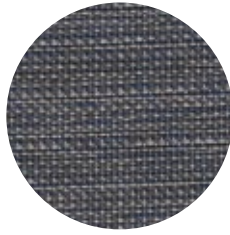

WV4003
Calm Blue

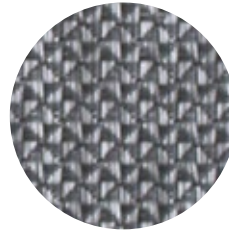

WV4004
Diamond
Cut Grey

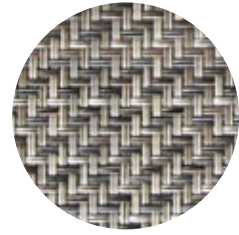

WV4006
Tranquility



WV4007
Spice

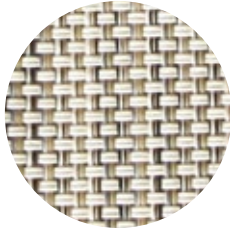

WV4008
Bold Beige

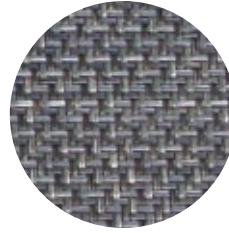

WV4010
Reflection

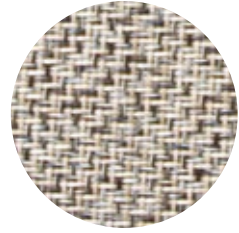

WV4012
Divine

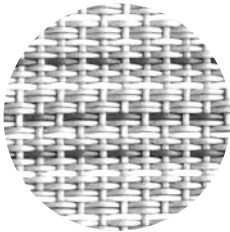

WV4017
White Stitch



WV4018
Ecru Hem

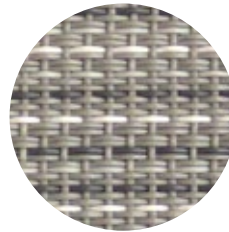

WV4019
Grey Stitch



WV4020
Jaggery



WV4021
Rapadura



WV4022
Silver

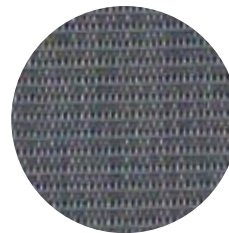

WV4023
Aluminium



WV5201
Slate

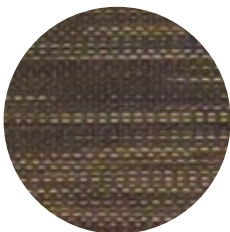

WV5202
Panela



WV5203
Coconut



WV5205
Charcoal

GLUE DOWN

TECHNICAL DATA SHEET

Floorer **Woven Glue Down** is available in sheets or rolls for glue down. The top is a textile layer composed of a core of polyester and fiberglass, encapsulated in vinyl to reinforce the resistance and wear. It has the feeling of the textile and all the advantages of vinyl: wear-resistant, easy to handle compared to textile floorings and simple to install. Being a textile product, this range has a tolerance of 2% asymmetry, known as skew and bow effect. Maximum fraying tolerance of 5 inner-yarns/ml guaranteed. It has all the textile properties and these may suffer variations or changes with time that may affect and alter the colour.

Roll Format



Tile

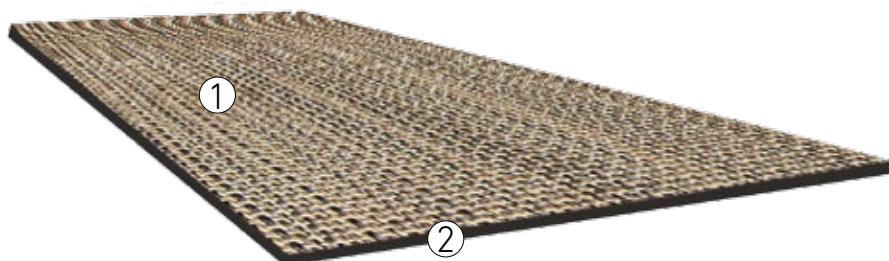
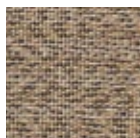

① Woven Vinyl

② Backing Vinyl

Characteristics	Test methods	Woven Glue Down Sheet	Woven Glue Down Roll	Woven Glue Down Tiles
Application		Furniture / Walls	Flooring	Flooring
Classification	EN 685	23/33	23/33	23/33
Dimensions	EN 427	915 x 305 / 928 x 634 mm	2 x 10 m	500 x 500 mm
Thickness (Woven + Backing Vinyl)	EN 430	1,8 mm	2,5 mm	3 mm
Weight	EN 430	2 kg/m ²	3,25 kg/m ²	4 kg/m ²
Abrasion resistance	EN 660-1: 99	0,068 mm	0,068 mm	0,068 mm
	EN 660-2: 99	1,80 mm ³	1,80 mm ³	1,80 mm ³
Chemical resistance	En 423	Class 0	Class 0	Class 0
Fire resistance	EN 13501-1	Class BFLs1 (B1)	Class BFLs1 (B1)	Class BFLs1 (B1)
UV Resistance	ISO 105	≥ Grade 8	≥ Grade 8	≥ Grade 8
Thermal resistance	EN 12664	0,075 m ² K/W	0,080 m ² K/W	0,085 m ² K/W
Fungus test	ASTM G21:96	Grade 1	Grade 1	Grade 1
Skew and Bow	EN 427	Max 2%	Max 2%	Max 2%
Slip resistance	EN 12633	Class 2	Class 2	Class 2
Residual Indentation	EN 433:1994	0.08mm	0.08mm	0.08mm
Dimensional Stability	EN 434:1994	0.05% (X + Y direction)	0.05% (X + Y direction)	0.05% (X + Y direction)
Curling	EN 434:1994	1.5mm	1.5mm	1.5mm
Assessment of Static Electrical Propensity I	SO1815:1997	1,2 kV	1,2 kV	1,2 kV
Acoustics Performance	ISO 140-8: 1997	Lw=12dB Cl=-9dB	Lw=12dB Cl=-9dB	Lw=14dB Cl=-9dB
Castor chairs suitability	EN425:2002	No effect	No effect	No effect

Recommended fitting patterns: Quarter turn, brick (one direction) or both: chessboard installation



LOOSE LAY

TECHNICAL DATA SHEET

Floover **Loose Lay** have a backing of PVC and fiberglass with a total thickness of 4,2 mm and is made in Tiles of 500 x 500 mm.

The top is a textile layer composed of a core of polyester and fiberglass, encapsulated in vinyl to reinforce the resistance and wear. It has the feeling of the textile and all the advantages of vinyl: wear-resistant, easy to handle compared to textile floorings and simple to install. Being a textile product, this range has a tolerance of 2% asymmetry, known as skew and bow effect. Maximum fraying tolerance of 5 inner-yarns/ml guaranteed. It has all the textile properties and these may suffer variations or changes with time that may affect and alter the colour.

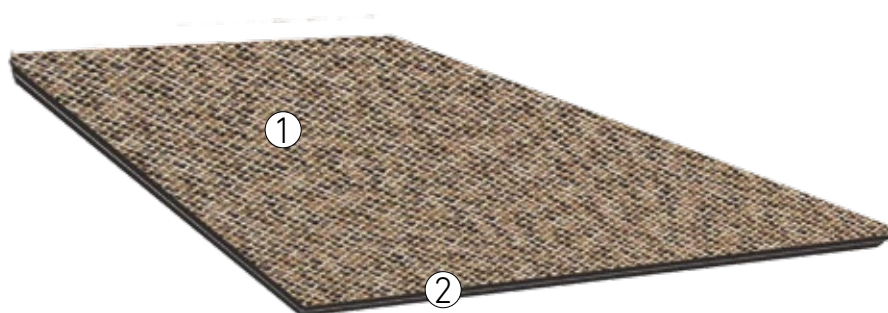

① Woven Vinyl

② PVC + FiberGlass + PVC

Characteristics	Test	Woven Loose Lay
Classification	EN 685	23/33
Dimensions	EN 427	500 x 500 mm
Thickness	EN 430	4,2 mm
Weight	EN 430	5,50 kg/m ²
Abrasion resistance	EN 660-1: 99	0,068 mm
	EN 660-2: 99	1,80 mm ³
Chemical resistance	En 423	Class 0
Fire resistance	EN 13501-1	Class BFLs1 (B1)
UV Resistance	ISO 105 - B02	≥ Grade 8
Fungus test	ASTM G21:96	Grade 1
Skew and Bow	EN 427	Max 2%
Slip/Slide resistance	EN 12633	Class 2
Residual Indentation	EN 433:1994	0.08mm
Dimensional Stability	EN 434:1994	0.05% (X + Y direction)
Curling	EN 434:1994	1.5mm
Assessment of Static Electrical Propensity I	S01815:1997	1,2 kV
Acoustics Performance	ISO 140-8: 1997	Lw=15dB Cl=-9dB
Castor chairs suitability	EN425:2002	No effect

Recommended fitting patterns: Quarter turn, brick (one direction) or both: chessboard installation

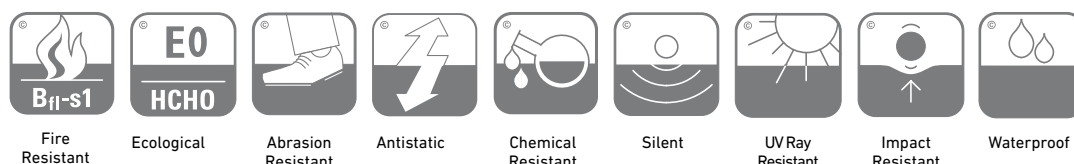

WOVEN ROLLS

TECHNICAL PROPERTIES/DETAILS

Woven rolls is a woven vinyl collection available in different solutions. The textile nature of this product and its fabrication process make it have some aspects to be considered:

1. BATCH LOT:

Because of textile process, the batch control must be considered, since is possible some little difference in color from 1 batch to another.

It is specified in each roll label:

Fab Week: 14 05 0032

Year Week Production Number

Special designs can be considered, but must be an approval process. Minimum 1000 m² and price must be +5% due to all set up process.

2. ROLL WIDTH:

The width of the roll is minimum 2000 mm, with possible + 50 mm. In case of narrow width it will be advice.

Special width can be considered, but waste must be considered and confirmed in each case.

Also pallet system will be affected.

3. ROLL LENGTH:

The length of the roll is min 10 m, some extra length can be considered in some cases.

Special lengths can be considered, but waste must be considered and confirmed in each case.

Also pallet system will be affected.

4. SKEW AND BOW:

Due to the textile manufacturing process, there could appear certain deviations that would affect the final result of the roll.

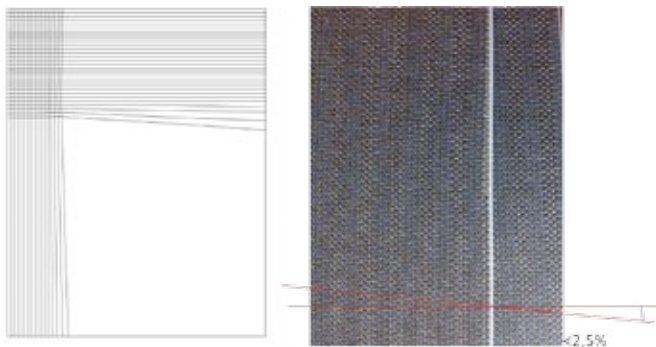

Deviation lower than 2,5 % must be accepted, it means that for every lineal meter the threat mustn't be deviated more than 2,5 cm.

5. FLAWS:

Flaws must be accepted in the maximum quantity of 1 per roll, and always considering really minor and just visual effect. Flaws will be mark width red strip on the sides and also indicated in the Flaw label (width the position in ml affected from the inner core).

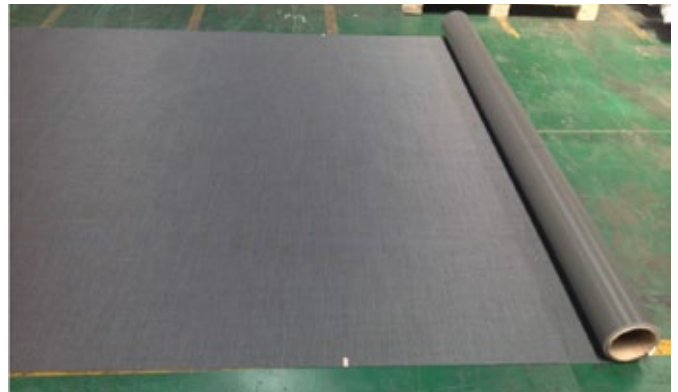

Flaws According to Levi's Four Point System Criteria

When a Flaw is detected, in that roll will be added 0,5 ml as a compensation.

Flaw Label:

	Quantity: _____ M
Flaw appear at: _____ M	
<small>Acceptable flaw, if they occur, shall only appear on the textile (not on backing). When this occur, an extra 0.5ml shall be added on the affected roll.</small>	

6. DIRECTION OF THE ROLL:

It's important for a design consistency, during installation. The direction is indicated by a

printed shaft on the back of the roll, together with the production date.

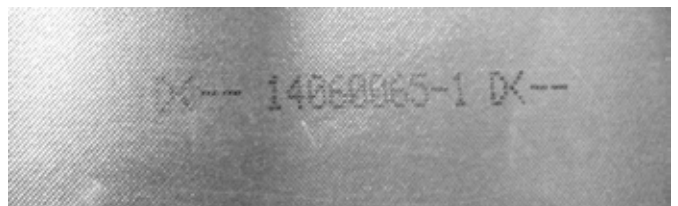

HDF

TECHNICAL DATA SHEET

Floover **Woven HDF** consists of 3 layers. The top is a textile layer composed of a core of polyester and fiberglass, encapsulated in vinyl to reinforce the resistance and wear. It has the feeling of the textile and all the advantages of vinyl: wear-resistant, easy to handle compared to textile floorings and simple to install. The elasticity and acoustic insulation of its structure give this product great comfort. The second layer is a 6,8 mm thickness HDF, that incorporates the Unilin clic installation system. The ultimate layer is 1,2 mm of cork, that gives an excellent thermal and acoustic insulation. Being a textile product, this range has a tolerance of 2% asymmetry, known as skew and bow effect. Maximum fraying tolerance of 5 inner-yarns/ml guaranteed. It has all the textile properties and these may suffer variations or changes with time that may affect and alter the colour.

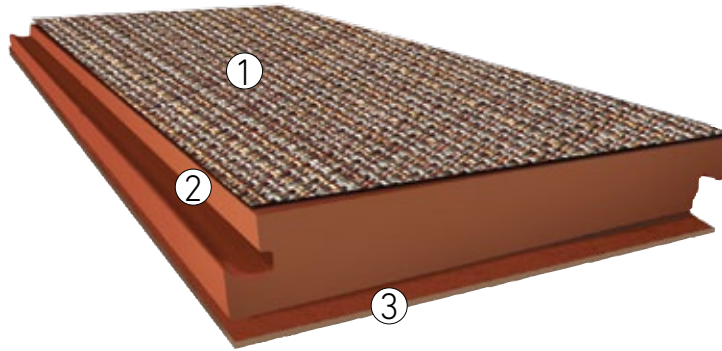

EP2624956A2 Patent FLoover

- ① Woven Vinyl 1,8 mm
- ② HDF 6,8 mm
- ③ Cork 1,2 mm

Characteristics		Test	Floover Woven HDF
Classification		EN 685	23/33
Dimensions		EN 427	913 x 303 mm / 915 x 305 mm
Thickness		EN 430	9,8 mm
Weight		EN 430	8,25 Kg/m ²
Abrasion Resistance		EN 660-1: 99	0,068 mm
		EN 660 -2: 99	1,80 mm ³
Fire Resistance		EN 13501-1	Class BFLs1 (B1)
Stain Resistance		EN 438	Grade 5 (Groups 1 , 2 and 3)
Dimensional Stability		EN 434	- 0,01 %
Curving		EN 434	0,2 mm
Acoustic Certification	Impact Sound	EN 10140	ΔLw= 21 dB
	Airborne Sound		ΔRA= 1,3 dBA
Cigarette burn resistance		EN 438 - 2	Class 1
Impact resistance		EN 1534	7,4 Kgf/mm ²
Slip/Slide resistance		EN 12633	Class 2
Flexibility		EN 435	10 mm
UV Resistance		ISO 105	≥ Grade 8
Skew and Bow		EN 427	Max 2%
Formaldehyde emission		EN 717	E1
Thermal resistance		EN 12664	0,088 m ² K/W
Antibacterial Test		ASTM G21	Grade 1



Fire Resistant



Ecological



Abrasion Resistant



Antistatic



Chemical Resistant



Silent



UV Ray Resistant



No Glue Installation System



Impact Resistant



Produced under license of Unilin - EP n. 0843763/515, patent n. 4.006.488

It's possible to lay 200m² without expansion joints. Maximum length 18 meters.

SPLASH₂O

TECHNICAL DATA SHEET

Floover Woven SplashH2O is a revolutionary product which is made of 2 layers. The top is a textile layer composed of a core of polyester and fiberglass, encapsulated in vinyl to reinforce the resistance and wear. It has the feeling of the textile and all the advantages of vinyl: wear-resistant, easy to handle compared to textile floorings and simple to install. The elasticity and acoustic insulation of its structure give this product great comfort. The second layer is a composition of rigid high density PVC of 6,5mm, produced by extrusion and 100% waterproof. Unilin clic system. Being a textile product, this range has a tolerance of 2% asymmetry, known as skew and bow effect. Maximum fraying tolerance of 5 inner-yarns/ml guaranteed. It has all the textile properties and these may suffer variations or changes with time that may affect and alter the colour.

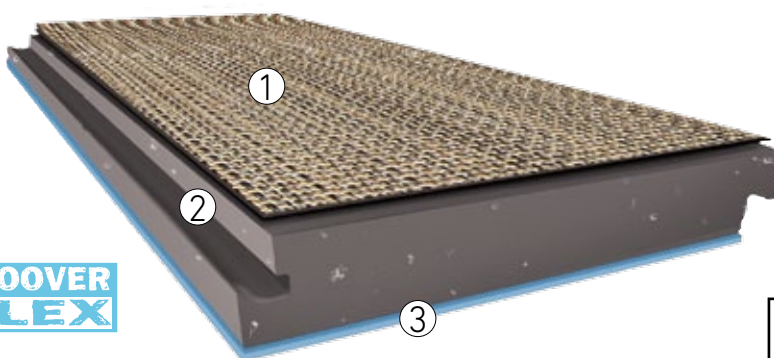

- ① Woven Vinyl 1,8 mm
- ② PVC Rigid 6,5 mm
- ③ Foam 1,5 mm (Optional)

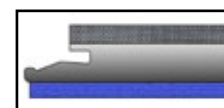

EP2614956A2 Patent Floover

Characteristics		Test methods employed	Floover Woven SplasH2O
Classification		EN 685	23/33
Dimensions		EN 427	915 x 305 / 913 x 303 mm
Thickness		EN 430	8.3mm
Weight		EN 430	8,8 Kg/m ²
Abrasion Resistance		EN 660-1: 99	0,068 mm
		EN 660 -2: 99	1,80 mm ³
Fire Resistance		EN 13501-1	Class BFLs1 (B1)
Stain Resistance		EN 438	Grade 5 (Groups 1 , 2 and 3)
Dimensional Stability		EN 434	- 0,01 %
Curving		EN 434	0,2 mm
Acoustic Certification	Impact Sound	EN 10140	ΔLw= 21 dB
	Airborne Sound		ΔRA= 1,3 dBA
Cigarette burn resistance		EN 438 - 2	Class 1
Impact resistance		EN 1534	7,4 Kg/mm ²
Slip/Slide resistance		EN 12633	Class 2
Flexibility		EN 435	10 mm
UV Resistance		ISO 105	≥ Grade 8
Formaldehyde emission		EN 717	E0
Water Resistant test		EN 317	0% Swelling
Thermal resistance		EN 12664	0,080 m ² K/W
Antibacterial Test		ASTM G21	Grade 1
Skew and Bow		EN 427	Max 2%

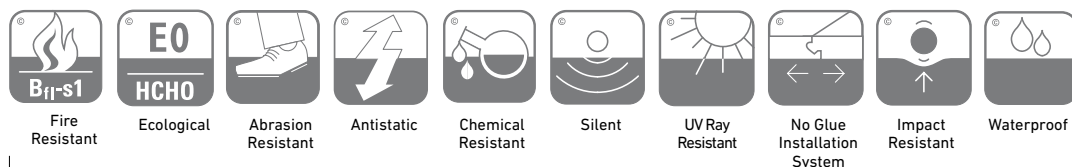

It's possible to lay 400m² without expansion joints. Maximum length 20 meters.

SPLASH₂0 LIGHT

TECHNICAL DATA SHEET

Floover **Woven SplashH2O Light** is a revolutionary product which is made of 2 layers. The top is a textile layer composed of a core of polyester and fiberglass, encapsulated in vinyl to reinforce the resistance and wear. It has the feeling of the textile and all the advantages of vinyl: wear-resistant, easy to handle compared to textile floorings and simple to install. The elasticity and acoustic insulation of its structure give this product great comfort. The second layer is a composition of rigid high density PVC of 4 mm, produced by extrusion and 100% waterproof. Unilin clic system. Being a textile product, this range has a tolerance of 2% asymmetry, known as skew and bow effect. Maximum fraying tolerance of 5 inner-yarns/ml guaranteed. It has all the textile properties and these may suffer variations or changes with time that may affect and alter the colour.

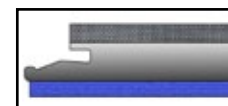
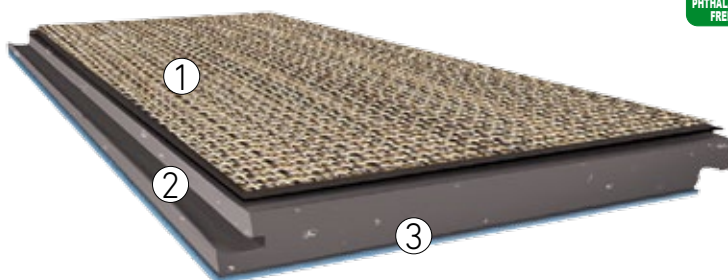

EP2614956A2 Patent Floover

- ① Woven Vinyl 1,8 mm
- ② PVC Rigid 4,0 mm
- ③ Foam 1,5 (Optional)

Characteristics		Test	Floover Woven with Splash Light
Classification		EN 685	23/33
Dimensions		EN 427	913 x 303 / 915 x 305 mm
Thickness		EN 430	5,8 mm
Weight		EN 430	7,63Kg/m ²
Abrasion Resistance		EN 660-1: 99	0,068 mm
		EN 660 -2: 99	1,80 mm ³
Fire Resistance		EN 13501-1	Class BFLs1 (B1)
Stain Resistance		EN 438	Grade 5 (Groups 1 , 2 and 3)
Dimensional Stability		EN 434	- 0,01 %
Curving		EN 434	0,2 mm
Acoustic Certification	Impact Sound	EN 10140	ΔLw= 21 dB
	Airborne Sound		ΔRA= 1,3 dBA
Cigarette burn resistance		EN 438 - 2	Class 1
Impact resistance		EN 1534	7,4 Kg/mm ²
Slip/Slide resistance		EN 12633	Class 2
Flexibility		EN 435	10 mm
UV Resistance		ISO 105	≥ Grade 8
Formaldehyde emission		EN 717	E0
Water Resistant test		EN 317	0% Swelling
Thermal resistance		EN 12664	0,080 m ² K/W
Antibacterial Test		ASTM G21	Grade 1
Skew and Bow		EN 427	Max 2%



Produced under license of Unilin - EP n. 0843763/13.15. patent n. 6.006.486

It's possible to lay 200m² without expansion joints. Maximum length 18 meters.

RAISED

TECHNICAL DATA SHEET

Floover Raised is a solution ideal for offices, museums or large areas where no prework for the subfloor or no soil preparation is needed. Intended particularly for workplaces, offices or technical areas where there is lots of cabling, pipes and other connections to be installed. Antistatic, durable, silent, antibacterial and warm.

RAISED SOFTCORE

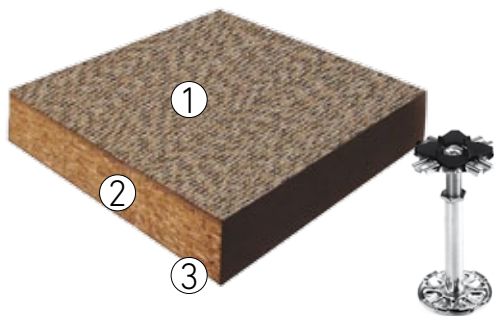

- ① Top Layer: Woven
- ② Core: High density chipboard. Thickness 38 mm
- ③ Bottom Layer: Aluminium foil

RAISED HARDCORE

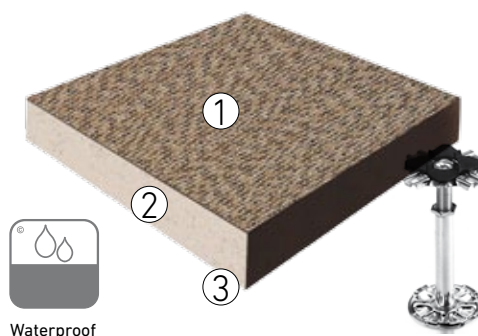

- ① Top Layer: Woven
- ② Core: Calcium Sulphate. Thickness 30 mm
- ③ Bottom Layer: Aluminium foil

	Characteristics	Test	Floover Raised SoftCore	Floover Raised Hardcore
CORE	Dimensions		600x600 / 600x900 mm	600x600 / 600x900 mm
	Tile thickness (without top layer)		38 mm	30 mm
	Chipboard density		700 kg/m ³	1450 kg/m ³
	Tile weight		26,7 kg/m ²	54 kg/m ²
	Concentrated load with pedestals, without structure		2 KN	4 KN
	Concentrated load with pedestals and Standard beams		3 KN	9 KN
	Concentrated load with pedestals and Heavy beams		4,5 KN	-
	Fire resistance		Cfl-S1	Bfl-S1
	Formaldehyde emission	EN312-1	E1	E1
	Thermal Conductivity		2,4 w/ m ² °C	3,5 w/ m ² °C
	Acoustic Insulation RLWP		≥ 50 dB	≥ 45 dB

TOP LAYER WOVEN	Abrasion resistance	EN 660-1: 99	0,068 mm
		EN 660-2: 99	1,80 mm ³
	Chemical resistance	En 423	Class 0
	Fire resistance	EN 13501-1	Class BFLs1 (B1)
	UV Resistance	ISO 105	≥ Grade 8
	Thermal resistance	EN 12664	0,085 m ² K/W
	Fungus test	ASTM G21:96	Grade 1
	Skew and Bow	EN 427	Max 2%
	Slip/Slide resistance	EN 12633	Class 2



Fire Resistance



Ecological



Abrasion resistance



Antistatic



Resistant to chemicals



Acoustic resistance



UV resistance



Impact Resistant

DECKING

TECHNICAL DATA SHEET

Pine thermo treated strips covered with a woven pvc sheet, with a total thickness of 22,5 mm, to be installed on autoclave-treated supports pine beams mounted directly on the subfloor. The flooring is made by interposing these strips, with the length of 200 cm, installed using stainless steel clips screwed onto the beam.

Woven Decking was originally designed for flooring, but it has excellent capacities in other areas: Thanks to its extreme ductility, Decking Woven can be also installed on walls.

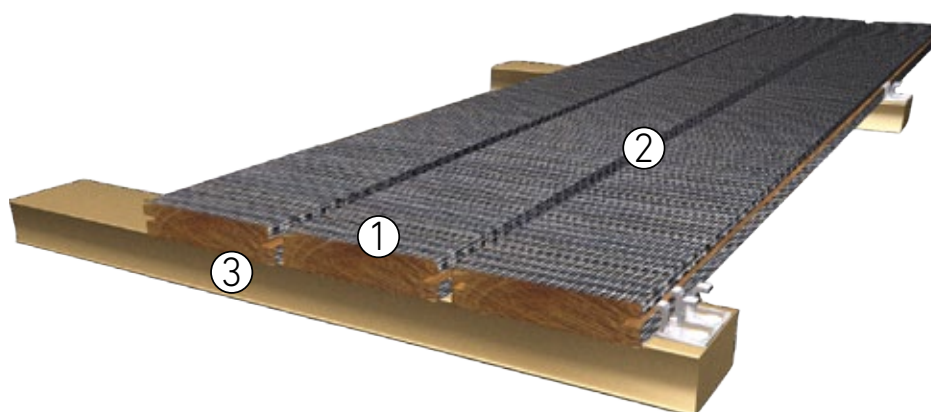

- ① Thermo-treated pine plank
- ② Woven PVC
- ③ Autoclave-treated pine/aluminium support beam

Dimensions (plank): 2000 x 98 x 22.5 mm

Dimensions (finished product with support): 2000 x 98 x 52,5 mm



PT / EP2013/069555 Patent Woven Decking

TECHNICAL CHARACTERISTICS	
Individual plank size: 2000 x 98 x 22,5 mm (±0,5)	No. of clips for sq.m: 25 pcs approx.
Gap between strips: 3mm	No. of screws for sq.m: 50 pcs approx.
No. of single pine supports for sq.m: 1,3 approx.	Center distance between pine supports: 40 cm

CHARACTERISTIC	REFERENCE STANDARDS	WOVEN DECKING
Strip frame	-	Thermo pine
Classification (superficial layer)	EN 685	Residential use: 23. Commercial use: 33.
Temperature resistance	-	No alterations between -25°C and + 135°C
Resistance to water	-	Swelling after 24h: 0,00%
Abrasion resistance	EN 660-1 / EN 660-2	0,068 mm / 1,80 mm ³
UV ray resistance	ISO 105	Grade 8
Spots and chemical substances resistance	EN 438	Grade 5 (Groups 1, 2 e 3)
Formaldehyde emission	EN 717	EO
Fungus resistance	ASTM G21	Grade 1
Slip / Slide resistance	EN 12633	Class 2 (Class 3 with additional treatment)

N.B. During the laying of the flooring leave 3 mm of space between the heads of the slaves in order to allow the correct dilataion of the material.

ACCESSORIES

FLOOVERFLEX



The definitive floor underlayment foam for water vapour control. Specially developed for Floorer Splash₂O and Splash₂O light solutions for installations in wet areas it reduces sound transmission and improves heat insulation.

① Flooverflex Alveolar:

Extruded polystyrene Foam HD-XPS

- No smashing effect (sound and pressure)
- Evaporation effect convenient

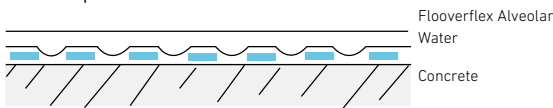

② Flooverflex Original: Vinyl Foam HD-HEPS

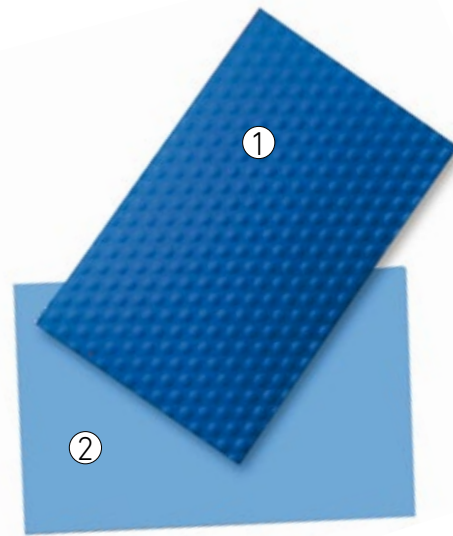
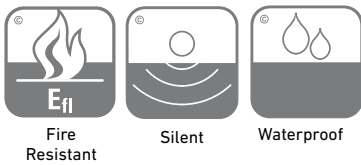

FLOORER SPLASH₂O AND SPLASH₂O LIGHT WITH FLOORERFLEX:

A finished product that saves labour and transport cost in just one component.

Characteristics	Test	Flooverflex Original *	Test	Flooverflex Alveolar
Colour		Blue		Blue
Material		HD-HEPS		HD XPS
Dimensions	EN 822	635 x 930 / 1245 x 954 mm	EN 822	635 x 930 / 1245 x 954 mm
Thickness	EN823	1,5 mm	EN 12431	1,5 mm
Load Resistance (in compression 0,5mm)	EN 826	≥ 200 (-20) kPa (t/m ²)	EN 826	≥ 500 (-50) kPa (t/m ²)
Thermal resistance	DIN 4108	- 0,039 m ² Kw	ISO 8302	- 0,0599 m ² Kw
Absorption	EN 12087	< 0,5 Vol. %	EN 13472	< 0,05 kg/m ²
Weighted reduction of impact sound's level	ISO 140-8	13 dB	ISO 140-8	19 dB
Weighted reduction of acoustic sound's level	CEN TC1276	5 dB	IHD- W 31	6,3 dB
Suitability for underfloor heating		yes **		yes

* Remarks: All above values are determined at laboratory conditions and with defined laboratory test sets. They can deflect in praxis or with other system components For all permormance data tolerances are possible due to uncertainty of the test method. The above statements reflect the current state of our knowledge, providing information about our products and their application. Therefore they can not guarantee particular product features or suitability for a specific application.

** Recommendation: The effective autobility for the application underfloor heating have been identified based on system component. The recommendation of BVF should not exceed the total flooring system of 0,15 m² K/W.

SKIRTING

CLIC SKIRTING

Available in every Floover decor. Skirting length depending on decor.

70 x 11 x 915 /1230 mm/1815mm

45 x 11 x 915 /1230 mm/1815mm



NEW CLIC SKIRTING

Available in very Floover decor. Skirting length depending on decor.

56 x 15 x 915mm/1230mm/1815mm



WOVEN INDOOR SKIRTING

Indoor skirting.

Box: 6 pieces (12 ml - 11,7 Kg)

Pallet: 10 boxes (120 ml - 117 Kg)

Piece: 2400 mm length - 1,95 kg)

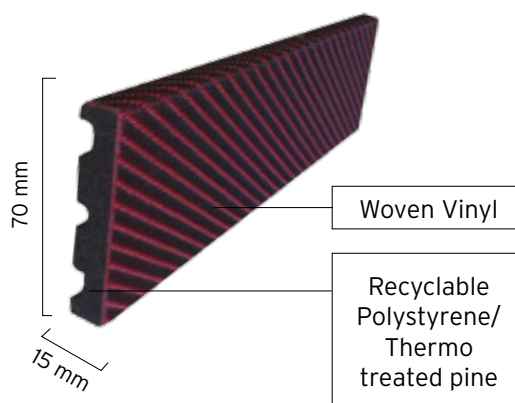

WOVEN OUTDOOR SKIRTING

Outdoor skirting.

Box: 6 pieces (12 ml - 9,95 Kg)

Pallet: 50 boxes (600 ml - 585 Kg)

Piece: 2000 mm length - 1,66 kg)

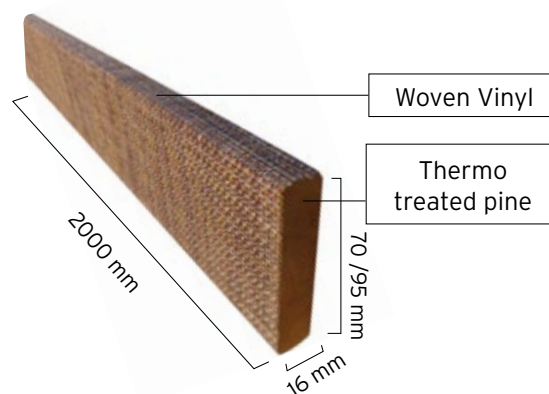

STAIRNOSE AND TRANSITION

STAIRNOSE 1 (WITH NOSE)

Same designs and textures as flooring. Perfect joint with Unilin Clic, it means there is no lip over. Perfect even connection to the flooring. Same length and thickness as flooring piece.

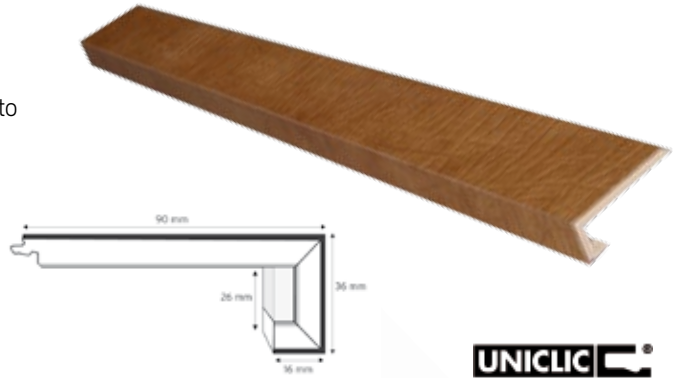

STAIRNOSE 2 (WITHOUT NOSE)

Same designs and textures as flooring. Perfect joint with Unilin Clic, it means there is no lip over. Perfect even connection to the flooring. Same length and thickness as flooring piece.



TRANSITION OVERLAP

Available in every Floover reference. Same level than the flooring. Same length and thickness as flooring pieces.



DILATATION JOINT

Same design and textures as flooring. Same length as floor planks.

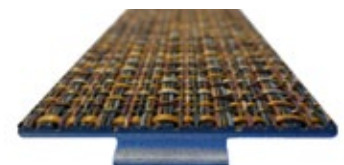

STAIRNOSE AND TRANSITION

STAIRNOSE CLASSIC 1A

Same designs and textures as flooring. Perfect joint with Unilin Clic, it means there is no lip over.

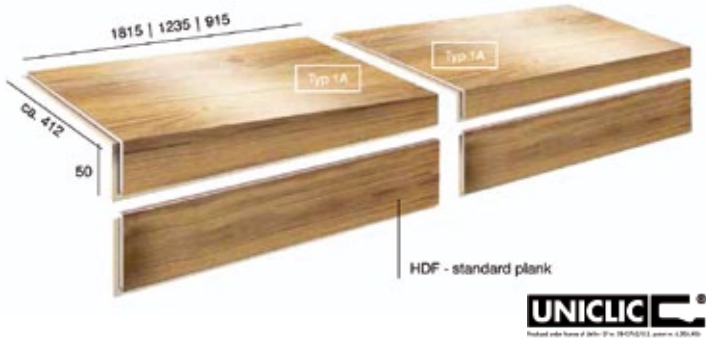

STAIRNOSE CLASSIC WITH SIDE FINISHING 1B

Same designs and textures as flooring. Perfect joint with Unilin Clic, it means there is no lip over.

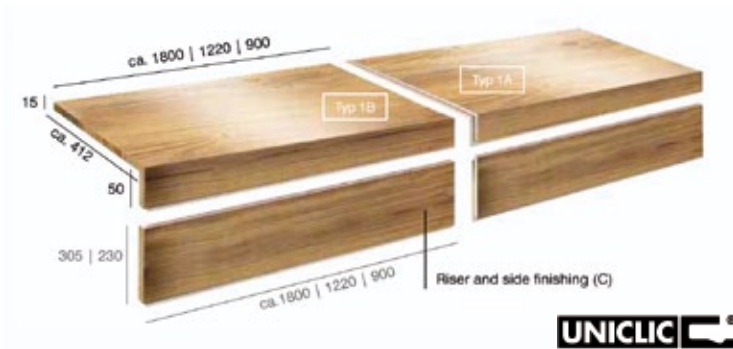

STAIRNOSE AND TRANSITION

STAIRNOSE WITH NOSE 2A

Same designs and textures as flooring. Perfect joint with Unilin Clic, it means there is no lip over.

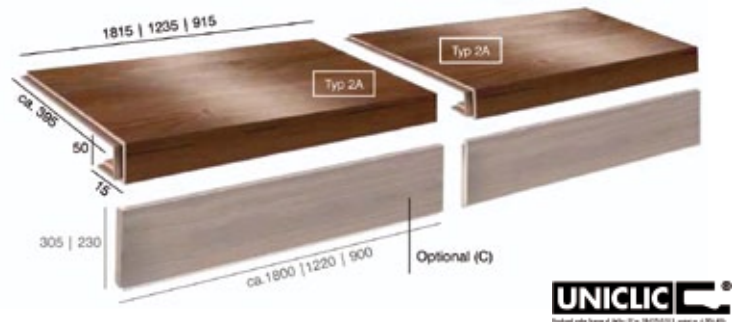

STAIRNOSE WITH NOSE AND SIDE FINISHING 2B

Same designs and textures as flooring. Perfect joint with Unilin Clic, it means there is no lip over.

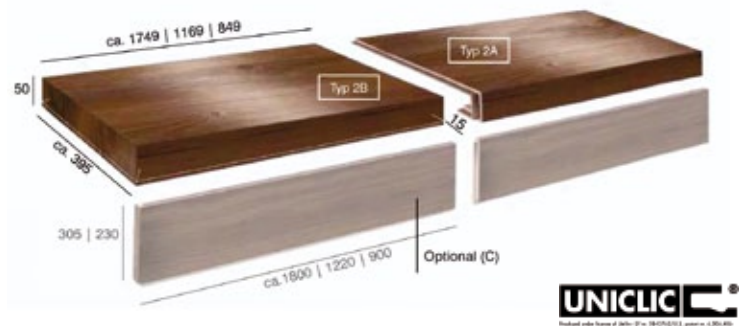

STAIRNOSE AND TRANSITION

ALUMINIUM STAIRNOSE

Perfect even connection to the flooring.
Length: 1,2 m

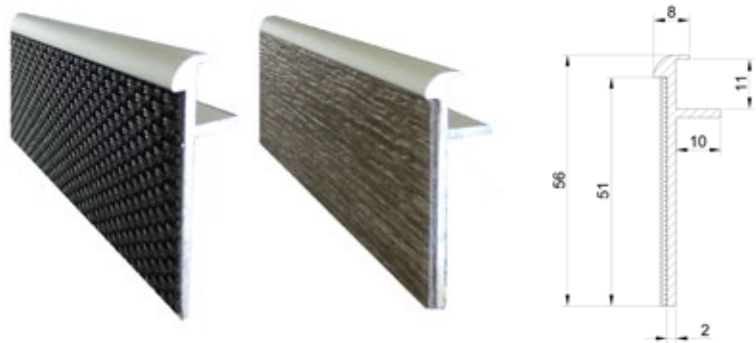

ANTISLIP ALUMINIUM STAIRNOSE

Perfect even connection to the flooring.
Length: 1,2 m



DECKING ACCESSORIES

CLIP STANDARD

Clip sizes: 41x38x11mm
Screw size: 20x5 mm
Average required: 25 clips/m² (50 screws)
To use with Pine Beam.

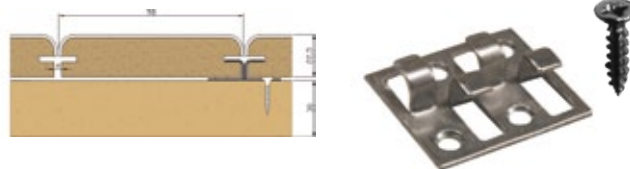

CLIP H

Clip sizes: 100x35x34 mm
(Includes screws and screw bit)
Average required: 25 clips/m² (25 screws)
To use with Aluminium Beam.

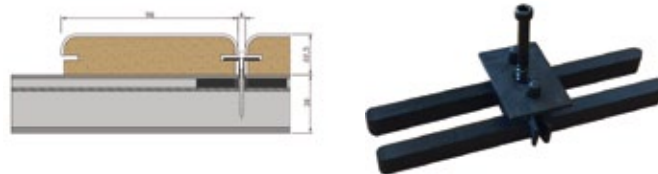

PINE BEAM

Autoclave-treated pine support beam. Ideal for outdoor use.
Size: 70x35x4000 mm (or shorter)



ALUMINIUM BEAM

Structural base beam made of aluminium for extreme humid conditions.
Size: 40x30x3000 mm (or shorter)



FLOOVER RAISED ACCESSORIES

PEDESTALS FLOOVER RAISED

Galvanized steel pedestals adjustable in height from 30 mm to 1800 mm, with conductive plastic lining.

Box: head 50 pieces + feet 50 pieces

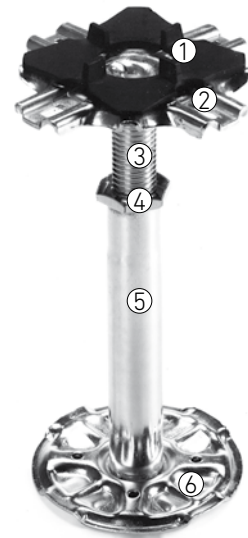

- ① **Plastic lining:** Latistat 48/9900-03 Y2c/ 15% PEBD
- ② **Head:** Diameter 90 mm with 2 mm thickness. Quality Stw22
- ③ **Threaded tube** with M16 thread. Quality TC310 TRECEM
- ④ **Fixing nut:** M16 0.7 mm thickness. DIN 796
- ⑤ **Tube:** Diameter 20 mm with 2 mm thickness.
Quality ST 34-2 (tube diameter increases with higher altitudes)
- ⑥ **Base:** Diameter 80 mm with 1.5 mm thickness. Quality Stw22

BEAMS FLOOVER RAISED

Galvanized steel beams with different characteristics, depending on the application:

1. **Standard:** 0.8 mm thickness. Clic system. Suitable to brace technical raised floors supporting normal traffic loads. Used normally from 25 cm in total height

2. **Heavy:** consists of a tube of 25 x 25 mm and 1 mm thickness. Are fitted by a self-tapping screw M5x12 mm.

Suitable to brace raised floors that support heavy loads (electrical panels, transformers rooms, etc. ...) and over 25cm height.

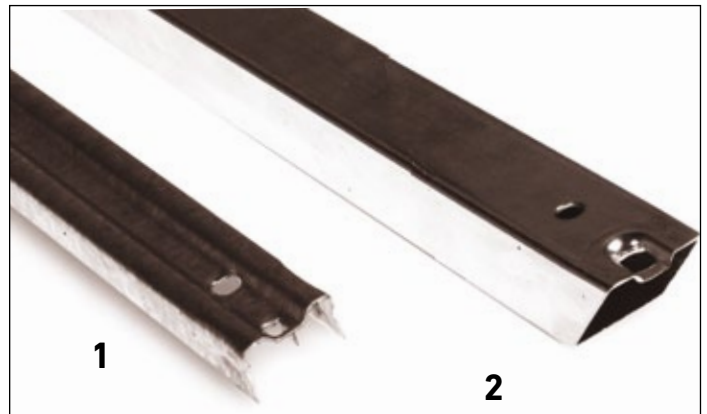

STANDARD

Box: 160 pieces (32 Kg/box)

HEAVY

Box: 120 pieces (48 Kg/box)

OTHER COMPLEMENTS

POLYPROPYLENE FILM

To install Floover flooring, just place the Polypropylene Film on the ground and seal the unions with masking tape, to ensure the vapour barrier as per the European rules. This is essential to ensure the proper performance of the flooring. 100m²

How to install polypropylene film

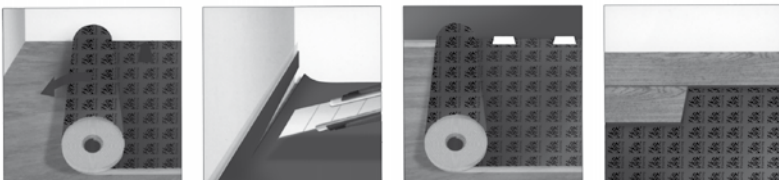

FLOOVER INSTALLATION

HDF/SPLASH₂O INSTALLATION

BEFORE INSTALLATION

Before, during and after the installation, the room must be preserved in paragraph ambient conditions delineated in the "air-conditioning".

Before the installation, make sure the product was not damaged during transportation.

Damaged material will be not replaced once installed.

Some differences of colour and structure are due to the nature of the material and so they can not be an object of a claim.

As with all natural products once exposed to sunlight there is a possibility that there will be some minor alteration in the colour.

Also, once the product is subjected to extreme ambient conditions of temperature and/or humidity some modifications of the dimensions of the board can occur between (5% and 8% dilatation). Immediately after installation, and before fitting the skirting, clean the floor with a damp cloth.

For the first cleaning please use special maintenance cleaner for PVC. Depending on level of use the flooring must be cleaned in regular intervals with topic cleaner.

Surface base: All surfaces where the product has to be fitted, must be predisposed to the laying, following principles in respect of the actual normative, in particular the requisites will be:

1. Dry and without humidity (With the exception of SplasH₂O version)
2. Level (with differences of level of 3 mm for one meter at least)
3. Compact and resistant screed
4. Cleaned and without crusts and dust
5. No anchorages of nails, screws or glues
6. Assure a stagger of the board not inferior of 300 mm
7. Maintain a distance of 10 mm from all the fixed structural works at the edge of the perimeter
8. In the areas, doors, passages or surfaces bigger than 200 m² and also in the length and/or width superior to 18 m, you have to consider the use of dilatation joints (SplasH₂O: 400 m² / 20 m)

AIR-CONDITIONING

The floor must be conserved at a temperature of the environment in which it will be layed for 48 hours before the fitting. The ideal conditions are 20°/22°C of temperature and 50- 60% of humidity.

Open the packs only when you install the flooring and mix the boards of the different boxes.

FUNDAMENTAL NORM FOR THE INSTALLATION

Place a layer fo PE-film of 0,2mm thickness on the entire installation area, which acts as a "Barrier of Vapour". Also recommended in SplasH₂O, to avoid bad odours and smells and liquid filtrations.

The joints of the different PE film sheets must be placed upon each other for min. 30 cm at least.

The flooring must always be fitted in a floating way, so without glue to the below surface.

Our range of indoor products is suitable for all types of spaces. Splash version is recommended for wet areas such as kitchens, bathrooms or SPA rooms.

This flooring shows different features: it is elastic, insulating in the thermic and acoustic point of view and it is easy to maintain. It is also resistant and simple to install. The floor has got a click system without glue and you can remove it in any moment without any damage and then you can re-install it following the initial instructions.

INSTALLATION

For the beginning it's necessary to have: the adhesive tape and the polyethylene film that is important as insulating against the vapour. The essential tools are: metre, pencil, saw, hammer, sealing, level, spacers.

After having lined up the first line of boards, lay the second line using the remaining piece of the last board of the previous line.

The joints of the boards between two different lines, must be

offset of 20 cm at least.

Install the first board lightly in diagonal as indicated and fix it, balance it lightly.

Proceed in the same way with the second board and position the frontal part of this last one against the first one.

Cut the board, necessary to complete the first line, in the part that expands on the surface to cover. Joint the boards laterally with a movement of 45° until to heard the click of closing and line up using the spacers.

The distance from the wall and from all the stable elements must be of 10 mm at least. (minimum 1,5 mm for every metre of width in the larger room).

You have to remove the spacers after the complete laying of the flooring.

The boards must be positioned in longitudinal way as regards to the light.

Cut the profiles of the doors at the high of the flooring, installation of the last line of the boards: measure the remaining distance between the wall and the last line.

Cut the boards in the length. Cut and lay them.

AFTER LAYING

Apply the felt pads under the tables, chairs etc...When you move heavy furniture, lift them and do not trail them. The office chairs must have rubber wheels in respect of the norms.

Skirting, profiles, repairing tools and detergents are very important accessories. Your retailer can suggest and show you a large range of accessories available.

Clean the floor with a humid cloth only after the fitting, and before the fitting of the skirting. For the first cleaning please use special maintenance cleaner for PVC. Depending on level of use the flooring must be cleaned at regular intervals with topic cleaner, never wet but humid and well squeezed.

The duration of your floor doesn't depend only on the use, but also from the maintenance and cleaning. Use only suitable products and follow our indications. Do not use aggressive essences with glycerine because they can attack the surface.

UNDERFLOOR HEATING

It is possible to install the floor on an underfloor heating system. Before installation it is necessary to have the heating system working at 25 – 30 °c for 10 days before installation, to ensure that any humidity which may be present has been dried.

Once the floor has been installed, put on the heating system gradually, increasing the temperature 2-3°c daily until it reaches the maximum temperature. This maximum temperature has to be maintained for a minimum of one day for every cm of the thickness of the subfloor and maintain for the whole night.

You must then continue to decrease the temperature 2-3°c everyday until the temperature of the flooring reaches 15°c (this should take approx. 10 days)

Any doubt please consult legislation UNE56810.

CLEANING AND MAINTENANCE

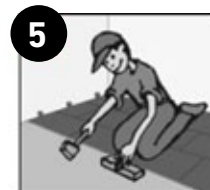
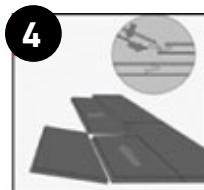
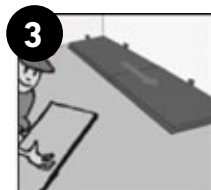

FLOOVER INSTALLATION

ENDLESS SYNCHRO

PACKAGING

Every box of Synchro Endless contains 6 different pieces which are installed 2 by 2 with Clic System. It is important to install as per the recommended guidelines as this ensures the continuation of the decor which enhances the authenticity of this product.



INSTALLATION SYSTEM

Floover Endless reaches maximum attractiveness when is installed in an appropriate way, locking maximum diversity of designs of installation. For this reason we recommend installing the pieces in the following procedure. It's also possible to mix short length pieces with double length ones, in order to achieve maximum differentiation.

	1	2	3	4
4	5	6	1	2
2	3	4	5	
6	1	2	3	
4	5	6	1	

It's also possible to mix short length pieces with double length ones, in order to achieve maximum differentiation.

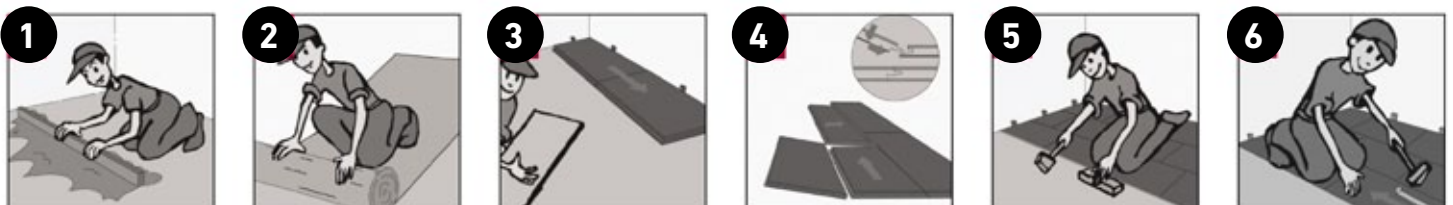

FLOOVER INSTALLATION

WOVEN GLUE DOWN (roll)



Floover Woven Glue Down is presented in two different ways: roll-packed (2000mm wide) and floor tiles (500x500mm). Floover Woven Glue Down products are suitable for indoor and outdoor uses.

Woven is made with vinyl material backed with PVC with a Polyester and Glass fiber core with a unique design and texture. Totally waterproof, anti-bacterial, colour-fastness resistant to light and very easy maintenance.

INSTALLATION IN ROLL:

REQUIREMENT OF BASE CONDITION

Note the following requirements depending on the different surface material:

- 1. Concrete:** Standard practice shall be followed. If the moisture condition of substrate is not reaching the standards, please treat the substrate with heavy-duty epoxy-based moisture control system and wait until is completely dry.
- 2. Wood:** Standard practice shall be followed. Please do not install our flooring products directly over plywood, treated wood or other uneven or unstable wood substrates. Always make sure the surface is clean, completely dry, flat and free of cracks. Dirt on the surface will affect the performance of adhesive and may telegraph to the surface once installed.

ADHESIVES AND SEALER

To reach a better adhesive result, please choose proper glue for different using areas and always follow user guides from the supplier. Here is a simple guide of how to choose the glue for:

- Low to moderate levels of traffic: chose an acrylic high quality glue such as Henkel K188E, Mapei ECO350 or similar.
- High levels of traffic: Use polyurethane compound glues, such as Henkel R710, or similar.
- Humid and wet areas: Use a water-resistant adhesive depending on subfloor material.

Cold welded sealer is recommended for roll installations; all the joints must be sealed with a cold welded sealer such as Werner-Muller-Gmbh type, or similar.

When fixing the flooring to the stairs, a protection mould is required for the front edge of each stair.

UNDERFLOOR HEAT SYSTEM

When installed on floors with under floor heat system, the temperature of surface cannot be higher than 29°C. Install your floor at least 7 days after the installation of under floor heat system is completed. Thermal resistance 0,060Kxm2/W.

The installation process must be done at a temperature no lower than 15°C.

Please, make sure all the flooring products are from the same item collection and made from the same lot. The Woven range is a vinyl textile therefore it has all the textile properties and these may suffer variations or changes with time. These variations may affect and alter the colour.

ROLL INSTALLATION

Roll-packed products are finished in approx. 200cm with some extra material allowing overlapping for proper installation. Always rolled out in the direction of length of the room - this will improve the appearance of the flooring and simplify the maintenance.

Remember to avoid seams across the flooring.

1. Draw a line 196cm away from the wall.
2. Lay out the flooring and follow the line's outer edge.
3. The next roll must overlaps by approximately 4 cm* (photo 1).
4. Cut through both lengths in the direction of the seam (photo 2).
5. Remove the surplus pieces (photo 3).
6. Spread the adhesive evenly on a half part of the area and allow it to aerate (photo 4).

7. Lay the roll down and erase any bubble using a heavy roller.

8. Repeat the same process (points 6 and 7) with the other half.

***NOTE:** For a Stripe design adjust overlap until the design meets. Then repeat double cut process (photo 5).

9. Cold welded sealing: Lift up both sides of the joint and apply recommended glue on the base subfloor. Glue down the material to achieve a perfect joint. Place special masking tape centered over the closely cut seam and press tightly with a roll (photos 6 and 7). Cut masking tape with a rolling knife in the area of the seam (photo 8). Apply the recommended glue inside of the seam and pull along (photo 9). Pull off masking tape once dried (photo 10).

FINAL FINISH

Use a white and damp clean cloth to wipe the surface of floor. Use Floover Cleaner when needed. Vacuum clean the whole area to make sure the cleanliness.

We recommend covering the whole area for next job operation. For intensive cleaning or long period renovation, we recommend use of Syntilor Composite Cleaner.

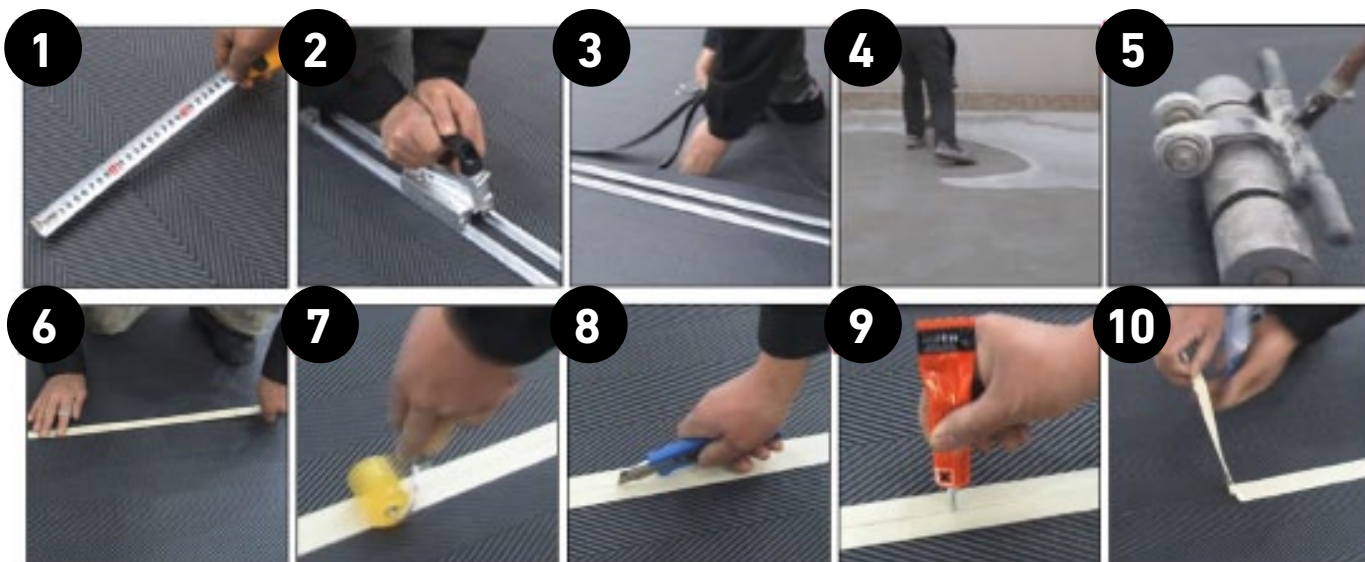

FLOOVER INSTALLATION

WOVEN LOOSE LAY

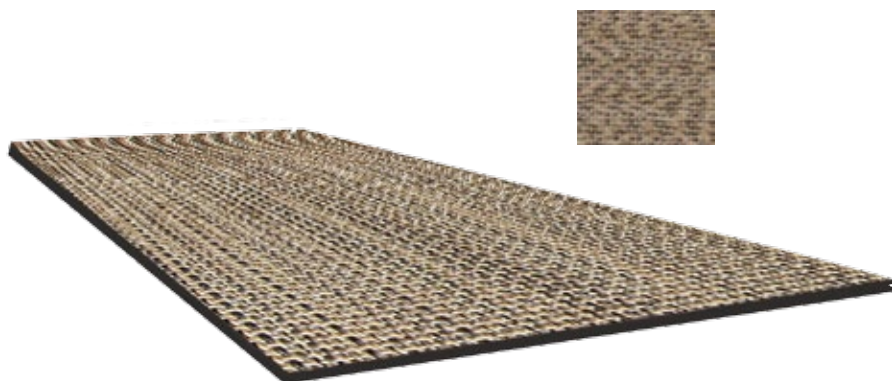

Flover Woven Loose Lay is presented in tiles with 4.2 mm width and a size of 500 x 500 mm. Woven is made with vinyl material backed with PVC with a Polyester and Glass Fiber core with a unique design and texture. Totally waterproof, anti-bacterial, colour-fastness resistant to light and very easy maintenance.

INSTALLATION:

REQUIREMENT OF BASE CONDITION

Note the following requirements depending on the different surface material:

1. **Concrete:** Standard practice shall be followed. If the moisture condition of substrate is not reaching the standards, please treat the substrate with heavyduty epoxy-based moisture control system and wait until is completely dry.
2. **Wood:** Standard practice shall be followed. Please do not install our flooring products directly over plywood, treated wood or other uneven or unstable wood substrates.

Always make sure the surface is clean, completely dry, flat and free of cracks. Dirt on the surface will affect the performance of adhesive and may telegraph to the surface once installed. The level of humidity must comply with the values prescribed in current norms: as a general rule, a maximum of 2,5-3% for cementitious substrates and 0,5% for gypsum or anhydrite-based substrates.

ADHESIVES AND SEALER

To reach a better adhesive result, please choose proper glue for different using areas and always follow user guides from the supplier. We highly recommend Ultrabond Eco Tack LVT. Before installation, we recommend drawing a draft of laying plan. Take a look to the arrow sign marked on the back side of each tile.

UNDERFLOOR HEAT SYSTEM

When installed on floors with under floor heat system, the temperature of surface cannot be higher than 29°C. Install your floor at least 7 days after the installation of under floor heat system is completed. The heating must be switched off at least 48h before, during and after the installation.

GENERAL CONDITIONS

The installation process must be done at a temperature no lower than 15°C. Please, make sure all the flooring products are from the same item collection and made from the same lot. The Woven range is a vinyl textile therefore it has all the textile properties and these may suffer variations or changes with time. These variations may affect and alter the colour.

TILES INSTALLATION

1. Start drawing two perpendicular lines, each one parallel to a wall, near from the room entrance (picture 1).
2. Spread the adhesive evenly over the entire surface (picture 2).
3. Wait until the water has completely evaporated before placing the flooring. At least 1 hour, depending on the type of substrate, the surrounding temperature and the amount of product applied (read the adhesive specifications). If the installation begins before the glue is completely dry, the adhesion could be permanent.
4. You can make the design looks different depending on the direction of the tiles (have a look to the arrow sign on the back of each tile). See recommended installation systems (picture 3).
5. Install the first tile from this cross section (picture 4) and follow the lines to fill the surface progressively (picture 5).
6. Complete the installation of all the tiles that mustn't be cut (picture 6).

7. To fit the perimeter cut the pieces before installing them. Place the tile that has to be cut on the last installed one. Push another tile to the wall and cut (picture 7). Then fit the cut piece (picture 8).

FINAL FINISH

Use a white and damp clean cloth to wipe the surface of floor. Use Floover Cleaner when needed. Vacuum clean the whole area to make sure the cleanliness. We recommend covering the whole area for next job operation. For intensive cleaning or long period renovation, we recommend use of Syntilor Composite Cleaner.

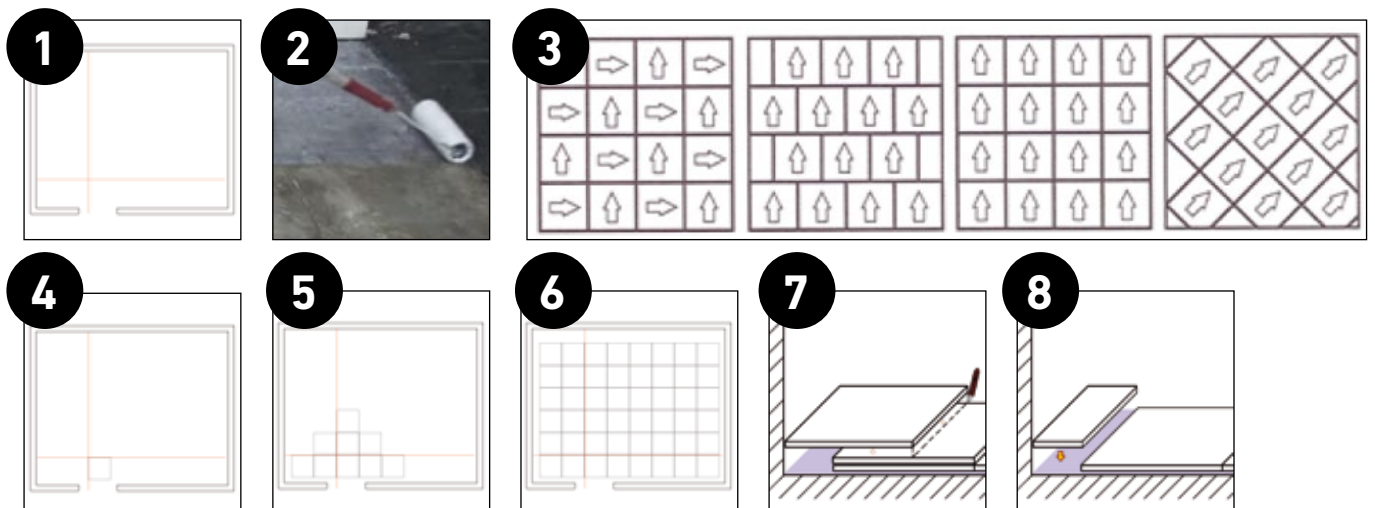

FLOOVER INSTALLATION

UNDERFLOOR HEATING

GENERAL INSTRUCTIONS

All Floover flooring can be used in conjunction with low temperature underfloor heating, under the following conditions. This is with underfloor heating systems with heating components - hot water or electric — embedded in the floor. The underfloor heating must be installed in accordance with the supplier's instructions and the generally accepted instructions and rules. The general installation instructions for Floover flooring without underfloor heating also apply of course, unless explicitly mentioned below. The flooring must be laid floating.

It's recommended to lay an underlay with built-in moisture barrier or begin with a separate plastic film of a minimum of 0.2 mm thick. In this case, use a single sheet of plastic foil, or use several sheets but make sure they overlap at least 20 cm and tape them together.

PERFORMANCES

The maximum allowed heat resistance (R) of a floor covering is 0.15 m²KJW (EN 4725), in order to achieve Energy saving rules established by CE organization and specified generally. All Floover products accomplish those requirements, and have the following values for energy saving calculations:

	STANDART HDF CONSTRUCTION	SPLASH ₂ O VERSION
FLOOVER ORIGINAL	0,088 K*m ₂ /W	0,080 K*m ₂ /W
FLOOVER SYNCHRO	0,089 K*m ₂ /W	0,081 K*m ₂ /W
FLOOVER PLUS	0,090 K*m ₂ /W	0,082 K*m ₂ /W

It's important to accomplish limitations of m² in 1 installation without joints: < 200 m² for Floover Standard / < 400 m² for SplasH₂O

CONCRETE OR SCREED AS SUB-FLOOR

The type of screed and the installation method, combined with the underfloor heating, must comply with the instructions of the suppliers of the screed and the underfloor heating system. To obtain a homogeneous heat distribution across the entire floor, the distance between the heating elements must not be greater than 30 cm. The depth of the elements is determined by the fitter of the underfloor heating.

The sub-floor must be sufficiently DRY across its complete thickness when installing the floor covering. This is maximum 1.5% according to the CM method for cement-bound floors and maximum 0.3% for anhydrite-bound screed.

This can only be guaranteed, when installed in new buildings, by starting up the underfloor heating. Start up the underfloor heating gradually at least two weeks before laying your FLOOVER flooring, and minimum 21 days AFTER laying the screed (max. 5° per day).

- at 50% of the capacity for 2 weeks
- 100% for the last two days.

For newly spread screed, follow the guidelines of your installer for the start up period. A heating protocol should be presented; ask for it if necessary.

FLOOR COOLING

More and more systems that combine heating and cooling are being installed in homes. A combination of heating in winter and cooling in summer can for technical and physical reasons be problematic in combination with organic floorings in general and with Floover in particular. Not for Floover SplasH₂O version, which resist all humidity and water condensation.

The installation instructions for Floover flooring on underfloor heating without cooling also apply here of course. However, it is important that floor cooling systems are equipped with an advanced control and safety system in order to prevent internal condensation (dew point regulation). To avoid damage to the floor, the supply temperature of the cooling water must not be reduced below a certain temperature, the so-called dew point temperature. Lower temperatures will produce condensation in the floor and damage the HDF / Cork layers: warping, distortion, swelling and gapping.

An effective control system consists of automatic probes that can detect when the dew point (= when condensation starts) is reached under or in the Floover, and then switch the cooling off. Room thermostats should never be set under 24°C. In addition, thermostats must never be set at a temperature which is 5°C lower than the room temperature. So at a temperature of 32°C, the room thermostat must not be set lower than 27°C.

The cooling circuit must have a control that prevents the temperature of the cooling liquid dropping below 18 to 22°C. This depends on the climate zone where the floor is installed. In zones with a high relative humidity, the minimum is 22°C; at average humidity and temperature levels, it can go as low as 18°C.

If you do not respect these instructions, the warranty Floover is void.

A heat resistance of less than or equal to 0.09 m²K/W is normally recommended for floor cooling. The heat resistance of Floover is always accomplished with that requirement .

HEATING FILMS

Heating films or other “new” systems ON the screed or wooden sub—floor are not always suitable. Further guidelines for these applications can be found below.

An underlay can be used to level the floor, to insulate it and in particular to embed the film elements and electrical connectors. The following structure is usually applied: first the underlay, then the heating film and then the FLOOVER floor.

For these systems the conditions that have to be fulfilled are that the heat must be distributed homogeneously across the entire floor to prevent any cold or warm zones, that the heat radiates up and not down, that the maximum contact temperature is not more than 27°C, and that the electrical connectors between the panels are thin enough to be sunk in the underlay mat while maintaining their strength and electrical safety, also in the event of possible condensation or a leak.

A second type of heating systems for renovation is a system with warm water pipes or electrical resistances embedded in frames. These are usually polystyrene panels which may be combined with metal plates. We consider these systems to be more reliable because they ensure a more homogeneous distribution of heat, provide heat insulation under the underfloor heating, have good contact and provide a stable sub-floor under the laminate floor. The above-mentioned notes still apply but we believe they are easier to fulfil.

FLOOVER INSTALLATION

STAIRS



USES AND DEVELOPMENT.

1. Before the installation, clean the surface and eliminate protuberances.

2. Cut the stairnose to the appropriate length of the step. If two sides or more, cut in 45° to make to sides.



3. Take the size and cut the piece of the surface of the step, using the clic system if possible or just normal glue to joint the stairnose cut previously.

4. Install the step in place, and finally the vertical side of the step.



5. It is also possible to cover the side of the step with the same stairnose product.

6. Repeat step by step this process till finalize your Floover stair.

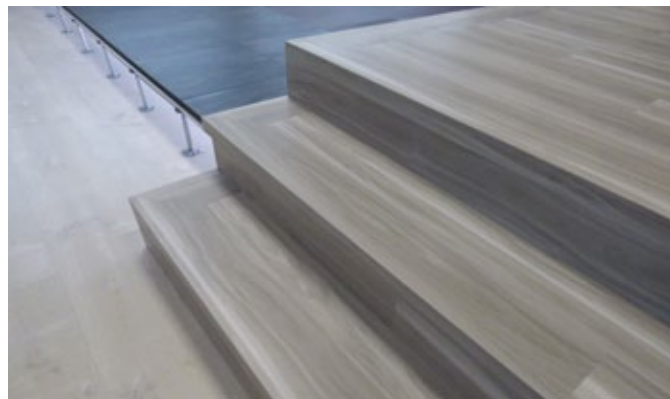

FLOOVER MAINTENANCE

CLEANING, MAINTENANCE AND RESTORATION



GENERAL MAINTENANCE:

The maintenance of Floover flooring is really simple and easy to realise. The R&D Floover department has developed a maintenance product for the Floover range: Floover Cleaner. A cleaner that takes care of the surface and maintains its original look. It can be used intensively with dissolution or directly over the difficult dust.

FLOOVER CLEANER

Presentation and Coverage:

1 L bottle with dispenser cap. 6 bottles/box. 1 dosing unit = 25 ml

Uses and indications:

Removes dirt, grease and shoe marks. Ideal for everyday maintenance cleaning and resilient flooring. Leaves the floor clean, bright and lightly scented.

High cleaning power due to the presence of active moisturizers and emulsifiers.

It acts quickly on dirt, grease, nicotine and fingerprints. No need to rinse and leaves no marks.

Surfaces:

- Especially suitable for water-repellent, resilient floor coverings.
- Also recommended for use on all other water-resistant, resilient types of floor coverings, such as PVC, linoleum, rubber as well as on coated floors.

Application Instructions:

- Dilute 25-50 ml (1-2 doses using the dispenser cap) in 5 litres of cold water. Depending on strength required.
- Wipe the floor with a well rung-out mop (no water on the floor)

* For effective cleaning, we recommend changing the water (10L water/ 4 caps of cleaner) every 50-100 m² depending on how dirty is the area.

VINYL RENOVATION

It is possible to renovate Floover flooring after heavy or aggressive use or after many years of transit. Due to the chemical composition of the protective layer, the flooring will deteriorate for the following reasons:

Deterioration of the polyurethane varnish/ Deterioration of the protective pvc layer

Surface Cleaning Process

First it's necessary to clean the whole area with an intensive cleaner as Blanchon Hiperactive to remove all the stain and remains of other products used before. Then use Blanchon Renovator or Blanchon Intensive if you want a higher protection layer. Also it's possible to restore scratches using a polishing sponge before cleaning.

INTENSIVE CLEANER.

Alkaline product especially designed to eliminate profound dirt, such as wax, other cleaning products and glue. This intense cleaning can be done with a cloth or with a large rotating machine for larger areas. Nevertheless this process will eliminate the protective polyurethane varnish and you will have to protect the flooring after.

Presentation and Coverage:

Concentrate solution to be dissolved in water. 1L. bottle. Coverage: 1L. de solución = 40 - 50 m² aprox.

Uses and indications:

Eliminates grease and dirt. Super-active stripper for all types of polish and metallized polish

Stripper: Thanks to its carefully selected surfactants strips all types of polish, including even old, thick polish build-ups, organic compounds and heavy alcohols.

Its anti-lime sequestering agents ensure its effectiveness, even with hard water.

Powerful degreaser which removes a wide range of grease stains.



Surfaces:

Heavy Duty Cleaner should only be used on varnished floors.

Strip polish from plastic flooring.

Application Instructions:

- Dilute 1 volume of Heavy Duty Cleaner in 10 litres of water (preferably hot water for better results)
- Spread the solution on the floor with a floor cloth or fill the buffing-machine tank.
- Clean with a buffing machine fitted with a black or thick green pad, or use a long-handled scrubbing brush.
- Remove any loose dirt and rinse with clean water.
- Aspirate and Mop Any loose dirt should be removed quickly by vacuuming or wiping with a scraper then a dust mop. We recommend rinsing first with a small amount of white vinegar added to the water to neutralise the product alkalinity.

* Use in wellventilated areas only. Can be used manually or with industrial machines. Never mix with other products.

RENOVATION WITH SPECIAL CLEANER SYNTHILOR

Floover Woven can be regenerated with the special cleaner Synthilor, recommended by Floover.



Presentation and Coverage:

1L. bottle to be dissolved in water or 0,5 L. spray for directly application.

Uses and indications:

- Protection and cleaning surfaces spotless and streak-free.
- Frequently maintenance for all type of vinyl flooring and composite decking material.

Application Instructions:

- Clean Thoroughly wet the ground and brush to remove any loose or semi adhered material.
- Shake well before use
- Dilute 2 glasses to 2 litres of warm water (with the exception of spray version, that is ready to be used)
- Apply widely in stages of 5-8 m² (using a sprayer is recommended)
- Leave for 5 - 15 min. without allowing the surface to dry.
- Rinse well with water, if there is not sufficient run off, clear the water with a rubber scraper to avoid drying marks.

IMPORTANT: On persistent stains/marks found on some materials re-apply or use the Special Cleaner in its highest recommended concentration (2 glasses to 1 litre of warm water) • In order to minimise the adhesion of grease and grime to the surface it is recommended to use it at least twice a year.

INTENSIV™



There is a way to give a higher resistance layer or to restore a worn out or scratched flooring more resistant than the Renovator. This could be useful when the traffic is higher than it was expected or to restore a deteriorated flooring.

BLANCHON INTENSIV

Presentation

Two-component product, water-based 100% polyurethane wood floor lacquer. Its technical performance and very low VOC rating formula complies with highly selective environmental requirements. It's available in 5 finishes: satin, matt, waxed oak, ultra matt and invisible effect.

Uses and indications

It's formulated with resins selected for their high resistance to abrasion, stains, wear and their remarkable flexibility. Also has excellent performance and is fast hardening and is ideal for all floor sealing jobs, particularly in high-traffic areas such as shops, offices, hotels, conference rooms, schools, corridors and entrance halls

Application instructions

- Clean properly the surface with Blanchon Hiperactive.
- Mix components A and B well in the following measures: 1 part Hardener to 9 parts Intensiv Lacquer (by volume).
- Apply the mixture using a short-haired roller on longitudinal direction.
- Wait 4 to 6 hours for before sanding/recoating.
- Don't wait more than 24 hours between coats.

WOVEN CLEANING AND MAINTENANCE

Floover Woven is a 100% washable product. It's very resistant to transit and scratch and even colour degradation. So that, no special maintenance products are required. This is a comparative with traditional carpets cleaning process:

	Carpet	Floover Woven
Type of cleaning	With vacuum cleaner	With water
Solution to spills	No resistance to spills, liquids, wine, etc	Complete resistance to all types of spills, liquids, wine, etc. Also resistant to high density grease. easy to clean.
Effects of vapors and smells	Negative affect of all filtrations of odors like smoke or sweat creating bad odors.	No affect from any type of filtration of bad odors.
Bacteria and mites	Retains all types of mites and bacteria. Difficult to clean and impossible to eliminate all.	ANTI-BACTERIAL Due to the structure and composition of the material and the easiness to clean, it is impossible to retain mites and other bacteria.

BLANCHON PROTECTOR

Once this process is done, we also recommend to protect our Woven vinyl with Blanchon Protector which shall make your flooring last longer in time apart from keeping it clean longer and free from dirt.

Presentation and Coverage:

White liquid which becomes completely transparent on drying. 1L. bottle. Cover around 40 to 50 m2 per litre per coat.

Uses and indications:

- Based on a new formulation, combining the hardness of metallised acrylic resins with the flexibility of polyethylene waxes, Blanchon Protector provides long-lasting protection and beauty to plastic flooring.
- Thanks to extremely minute components, it fills the wood pores preventing dirt build-up and forms an even coating with outstanding wear resistance. No buffing required.
- Non-Yellowing and non-Flaking thanks to the high stability of its copolymer ingredients
- With its specific adhesive properties, it's the key element in providing a protective coat on floors which are subject to heavy traffic

Application Instructions:

- Damp-Clean the surface before it is treated using Blanchon Heavy Duty Cleaner. The floor should then be rinsed with a damp.
- Dry the floor. Protector must be applied onto a clean, dry, grease-free surface.
- Apply 1 or 2 coats of Protector using a sponge mop, a micro-fiber mop dust mop or floorcloth.
- Wait 1 hour between each coat to allow for in-depth polymerisation. After this, wait 1h30 to return to use.



IMPORTANT: On pre-varnished wood floors which can be very hygroscopic (beech, etc.), first test on an inconspicuous area. Protector is sensitive to alkaline detergents.

Maintenance and Restoration:

Routine cleaning: use a vacuum cleaner, broom or lamb's wool cloth. Occasionally, damp-clean using a well wrung out cloth or mop (never a soaking wet one) using Daily Cleaner. Do not use abrasive detergents or products containing ammonia or silicone.

Maintenance can be alternated with Blanchon Maintenance. Protector can be applied over itself: occasionally, apply a thin coat to give a perfect finish.



APPLICATIONS & TECHNOLOGY

Floover proposes high quality flooring for both domestic and residential uses, using new technologies and creating new designs requested by the market.

APPLICATIONS

Thanks to its characteristics and high resistance, Floover can be installed in many areas. Just choose the range and the decor that best suits your needs.

COMMERCIAL USE

Shops, restaurants, sports centers, offices, stands, nightclubs, airports, stations, etc.

RESIDENTIAL USE

For any room in your home. Even in wet areas like kitchens or bathrooms.

SPECIAL APPLICATIONS

- Isolation 100% from the subsoil (laboratories, operating rooms and hospital clean rooms or clean rooms for handling organic items, cosmetics, etc ...)
- Stores or workshops in contact with pneumatic tires.
- Additional resistance for anti scratch for industrial areas

You can apply special surface treatments on Floover floors. We recommend contacting companies specializing in these treatments, as Dr. Schutz (www.dr-schutz.com)

TECHNOLOGY

Floover is the result of advances made in the world of engineered floors:

- Combination of vinyl on HDF
- Clic system with Unilin Licence, assuring the best installation system possible.
- The best vinyl in the market in terms of resistance and elasticity.
- Vinyl certificated 100% virgin. We can assure you that we comply with the emission norms, with the stamp U.
- Best quality HDF, with FSC certification.
- Our company is associated with some of the best industrial partners to assure the best quality and service and we design innovative products and launch them into the market to create the tendency in the world of innovative flooring.
- Our factory has a flexible and adaptable service so that all your needs can be met, always thinking of the best way to work in order to help the environment.
- We have product certificates from the best laboratories: EN Applus, CE Marth, ASTM



FLOOVER COMPARATIVE

FLOOVER/LAMINATE

DESIGN

Floover uses the vinyl design technology, which means, colour design much more accurate and surface structure more developed. Also the motives have been traditional very wide (Metallic, Cements, Ceramics, Leather, etc...) with endless possibilities. Also we have a technical department which permits you to design the decor you desire. One sample, one idea and the floor that you imagine can be yours.

WARM AND REAL SURFACE

Vinyl proprieties give a warm surface, much more close to real wood than laminates, because of overlay composition. Surface temperature is a very important component of comfort.

ABRASION RESISTANCE

From the abrasion point of view, laminate is a very resistant product, because of Overlay composition, but the thickness of the overlay is very reduced in comparison with Vinyl. From optical point of view vinyl can be damaged easily, but on long term performance, vinyl is giving excellent results.

IMPACT RESISTANCE

This performance is clearly much better on Floover than any laminate. Vinyl will be not affected by any impact, compared to laminate which can be damaged definitely.

ANTISTATIC

Because of the vinyl composition, there is not static electricity produced on the floor.

FIRE RESISTANCE

Floover has a good Fire Retardant performance because of the PVC charges. Vinyl layer will retard the HDF fire performance, compare to laminate. According to European norm, EN13501-1 Floover is classified as Bfl S1.

WATER RESISTANCE

Floover offers an excellent performance against water from the top. Even on top of the joints water remains on the surface and never filter to the bottom layers, improving the performance of any laminate, because of the elasticity of the top surface which makes a pressured joint connection.

SOUND REDUCTION

Floover composition is focused on the sound reduction performance. Even of reflected sound or transmitted sound, the performance is excellent, even for the vinyl layer and specially because of the cork bottom layer. Excellent performance for Hotel, Music Halls, or any place where high sound reduction performance is required. Much better than any laminate performance.

INSTALLATION

The Unilin Clic system is a guarantee of easy installation. Also the size of the planks (915x305 mm) are helping on the quick installation. But the real advantage in front of laminate is the product stability. It allows to install 200 m² without any dilatation joints. Also the perfection of the joints, because vinyl elasticity makes a perfect installation view.

COMFORT

Floover is a real experience of comfortability when you walk or lay on the floor, compared to any laminate of the market.

FLOOVER COMPARATIVE

SPLASH₂O / OTHER PRODUCTS

Today, we can find many Lvt (vinyl) clic floors in the market, but Floover is the only one which can offer a stable and waterproof vinyl floor with a rigid core.

	Floover SplasH ₂ O	Flexible LVT Clic	Flexible LVT on HDF Boards	Laminate
Clic system fast and easy installation	YES	YES	YES	YES
Installs in large rooms (up to 400m ²) without expansion joints	YES	NO	NO	NO
Minimal floor preparation	YES	NO	YES	YES
Adds warmth to the floor (walking comfort)	YES	YES	YES	NO
Resists subfloor mold and mildew	YES	NO	NO	NO
Noise reduction	YES	YES	YES	NO
Eliminates telegraphing that is associated with other floors	YES	NO	YES	NO
Repels water without damaging the flooring	YES	YES	NO	NO
Clic Resistance up to 600 kg/ml	YES	NO	NO	NO

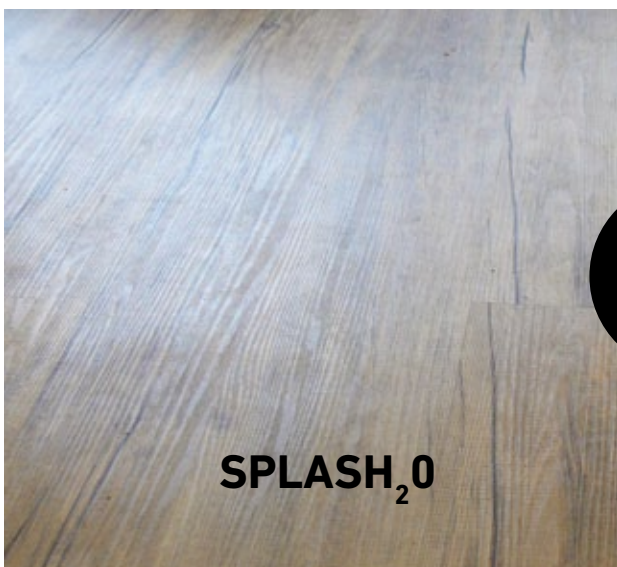

FLOOVER WARRANTY

WARRANTY CONDITIONS AND COMPLAINS

Floover Flooring warranty is maintained for a period of 15 years (from purchase date) adhering to the following conditions:

This warranty is valid if:

- The product has been installed under all indications of Floover laying instructions which appear on the back of the packaging.
- The product must be maintained periodically, according to the instructions recommended by Floover. This warranty is not valid if the effects are produced by the incorrect maintenance and insufficient frequency, for methods or materials not adequate, cuts or marks caused by sharp objects.
- The warranty is subject to appropriate use or per adequate conditions of temperature or humidity, indicated in the laying Instructions text.
- Defect for over abrasion is defined if it affects an area over 10% of the total area installed.

Warranty applies for the following aspects:

- Floover will retain its dimensional stability, as indicated on technical data sheet.
- Different components will remain glued, (with conditions not over 70°C) as indicated.
- Joins between pieces will remain closed, in installations up to 200 m² or maximum length of 18 lm, without the use of T joins (or sizes indicated in technical data sheet).
- The colour will be not modified by sunshine, with proper use. Obviously, extreme exposure to sun or extremely aggressive chemical products can affect the design, and will be excluded from this warranty.
- Static electricity will be not produced by slipping.
- In case of Glue Down application, connection to the base is not included in warranty since depends on glue performances and subfloor conditions.

Under the following installation conditions:

- Surface must be dry and no over humidity (<2,5% in concrete and between 40-60% in ambience humidity), except in case of SplashH₂O product.

- Base Floor levelled with a difference ± 3 mm per meter as maximum).
- Sub floor material must be concrete or any other compact and resistant floor.
- Base Floor must be in good conditions, clean (no screws or glues) and free of objects.
- Distance between joins not less than 300 mm between pieces is recommended.
- 10 mm of empty space for dilatations all over the perimeter, including structural elements.

Under the following conditions of use:

- Adequate use recommended by Floover according to the category selected.
- Dimensions and conditions of the room must be appropriate (sub floor conditions, ambience humidity, etc...) and in the case of under floor water heating system, adhere to the protocol of start up.
- The maintenance must be as according to the Floover laying Instructions. For initial use, Floover recommends Floover Cleaner

Once a complaint is submitted according to Floover instructions, and in case that the Complaint is Accepted, the customer will receive a replacement of the material (or similar or superior quality in case of impossibility), delivered in the same original destination.

Any installation costs, de-installing flooring, etc... are not included in the fabrication warranty.

If the Complaint is produced after 1 year of the installation of the material, an annual accumulative reduction is applied from the purchase value of -4% per year.

FAQ

FREQUENTLY ASKED QUESTIONS

WHICH ARE THE MAIN APPLICATIONS FOR FLOOVER PRODUCTS?

Main applications are offices, hotel rooms and corridors, VIP rooms and common areas, gyms and bathrooms, retail stores and exhibition points. It is also commonly applied in walls and furniture covers. Always used in indoor applications. For outdoor applications, please see Floover Hortus range product

IS FLOOVER A RESIDENTIAL OR COMMERCIAL PRODUCT?

Floover is a professional floorcovering for commercial areas where all technical properties of the material correspond to this use. Of course this is also appropriate for residential use.

IS IT SUITABLE FOR SUBFLOOR HEATING SYSTEM?

Yes, it is. Just need to follow the procedures on the installations instruction. Also good heat transmission ratio for environmental and efficiency aspect has been proved according CE standards.

IS FLOOVER SUITABLE FOR CHILDREN AREAS?

Yes, it is. Floover is also used in kindergartens, playgrounds and game rooms. Its core structure is soft and smooth.

IS IT SUITABLE FOR HOSPITALS?

Yes it is. It is used in treatment rooms, corridors, guest rooms, cafeterias and other public areas. Note: Floover Woven range is not recommended in surgery rooms

IS IT SUITABLE FOR HIGH TRAFFIC-AREAS?

Yes, it is. Floover products are mainly classified Class 33, suitable for heavy traffic due to the special yarn construction. Floover Original collection is classified as Class 32, which is recommended for housing, but the rest of the products are Class 33 specially recommended for high traffic areas, such as shops, open-plan offices and public halls.

DOES IT SOUND WHEN WALKING ON THEM?

Impact sound insulation varies for different products from 12dB to 22 dB, depending on the product construction and sub-floor installation.

IS IT SUITABLE FOR CHAIR CASTORS?

Yes, use chairs with hard castors whenever possible (polyamide).

IS FLOOVER FLOORING ANTI-STATIC?

Floover flooring does not generate a static charge because of the construction of the multi-layer. Floover flooring products have been tested and fulfil the requirements of the European Directive ISO1815.

WHAT ARE THE DIFFERENT INSTALLATIONS SYSTEMS FOR?

Floover products on clic system are suitable for medium and small areas, where the floor is not perfectly flat and floating system is accepted. They can be produced on HDF boards to be used when there is no humidity risk, or in waterproof boards (Splash) and these are used in bigger areas (>200m² up to 400m²) where joints are not required.

Floover rolls are the perfect application for professionals when required for bigger areas – glue down system and welding joints are needed.

Floover tiles is the easiest solution when it comes to glue-down system.

Floover Hortus is specially designed for outdoor spaces.

DOES FLOOVER FLOORING NEED ANY PARTICULAR MAINTENANCE?

Floover flooring systems can be easily cleaned with water and soap. We strongly recommend using Floover Cleaner, or in any case a specific vinyl cleaner.

Floover floors can be restored periodically with an intensive or heavy cleaner product and would look as good as new. See our maintenance guide” for more details. You can also watch our tutorials on Floover Flooring Channel in Youtube (www.youtube.com/flooverflooring)

IS IT POSSIBLE TO CUSTOMIZE A FLOORING SOLUTION IN COLOUR OR DESIGN?

Yes, it is. Check specific requirements in quantities.

DOES FLOOVER PROVIDE A SKIRTING SYSTEM?

Yes, we do. Floover supplies traditional skirting but also waterproof skirting, stair nose, transition and dilatation joints for all the colours available in Floover range.

DOES FLOOVER HAVE GREEN CERTIFICATES?

All Floover products are “Ü Zeichen” certificated for their extremely low emissions. All our products hold a high class rating certificate based on different criteria. The product also holds CE for health and fire concerns, as well as ASTM tests. Floover presents all its vinyl collections with a technology evolution that allows us to improve the emissions performance by eliminating completely any phthalate emission from its products, making them the safest for your children.





HEADQUARTERS

Parc Empresarial Mas Blau. C/ Selva, 4.
08820 El Prat de Llobregat, Barcelona (Spain)
Tel. +34 938 913 310

FACTORY

Palü Daint
CH - 7537 Müstair (Switzerland)
Tel. +41 818 503 944 / Fax. +41 818 503 945

WAREHOUSE

St. Bartlmä
06020 Innsbruck (Austria)
Tel. +34 938 913 310