



**PanelPiedra®**

Colección  
**CEMENT®**

---

Acabados de Productos

Fichas Técnicas

Gama de Colores

# SOLICÍTENOS **PRESUPUESTO**

Si desea más información de este producto

**+34 941 181 091**

[info@panel piedra.com](mailto:info@panel piedra.com)

**PanelPiedra®**

Polígono Industrial Municipal  
Vial Transversal 2  
31500 TUDELA (NAVARRA) SPAIN  
[www.panel piedra.com](http://www.panel piedra.com)



- El panel más ligero del mercado.**
- La instalación más fácil y sencilla.**
- El panel con la colocación más rápida del mercado.**
- Importante ahorro en costes.**
- Acabado perfecto.**
- No necesita mantenimiento.**
- Excelente aislamiento acústico.**
- Buen aislamiento térmico y anti-humedad.**
- Elegantes combinaciones de materiales.**
- Facilidad de transporte y manejo.**

Nuestra dedicación constante a la investigación tecnológica nos ha permitido desarrollar un producto perfecto y vanguardista en un campo en constante evolución, como es el mundo de la decoración y el diseño.

Ofrecemos las mejores soluciones estéticas para las últimas tendencias en diseño e interiorismo, cada vez más iconoclasta en la combinación de formas, colores y materiales.

Nuestros sistemas de fabricación patentados nos permiten una reproducción fiel de texturas y tonos de piedras, ladrillos y vigas, pero además la facilidad de instalación, resistencia y calidad convierten a nuestro producto en uno de los más demandados por los profesionales expertos.

La utilización de los productos Panel Piedra permite crear ambientes que combinan elegancia, diseño y calidad.

#### **PR: Panel de poliuretano con piedra.**

Panel compuesto por una capa de 4 mm. (aprox.) de polvo de mármol (piedra) y una capa de inyección de poliuretano de alta densidad.

Todo ello hace que sea muy resistente a todo tipo de inclemencias climatológicas (lluvia, sol, heladas, niebla, salina, etc.)

Es apto para su colocación en interior y en exterior. Excelentes propiedades saliente térmicas, acústicas y anti-humedad.

#### **HD®: Panel High Definition.**

HD® es un producto muy innovador de carácter mundial para revestimientos de todo tipo de paredes, muros y techos, compuesto con más de 16 tipos de cargas, minerales y químicas (piedra, mármol, sílices, silicatos, etc.) que lo hacen muy resistentes al exterior, al fuego y todo tipo de inclemencias climatológicas en el tiempo, como a su vez gran resistencia a la abrasión y productos químicos. También goza de una gran cualidad que es su bajo peso y su alto volumen, que todo ello hace que sea muy fácil su colocación. Es muy apto para lugares públicos de gran tránsito de personas, fachadas y grandes construcciones, lugares con mucha humedad, saunas, etc.

Excelentes propiedades ignífugas, hidrófugas, si inalterabilidad al choque térmico y a sus ciclos de hielo y deshielo, su nulo porcentaje de absorción de agua garantiza su completa estanqueidad, su alta resistencia a la mayoría de productos químicos, junto con su mínimo desgaste por abrasión, hacen que el producto HD® sea un material de alta calidad.

*Panel Piedra se reserva el derecho a cambiar los modelos, colores, tamaños, envases y cajas sin previo aviso. Todos los pesos y dimensiones mencionadas son en cm y se muestran con la mayor precisión posible, pero pueden diferir hasta 2% por la expansión y la contracción durante la producción. Las fotografías de este Catálogo se crean en lugares del proyecto y en estudios, algunos incluso podrían ser animaciones. Las diferencias en la exposición de la luz y la impresión en papel pueden causar que los productos y los colores se vea diferente que en la realidad.*

#### **PR: Panel de poliuretano con piedra**

#### **HD: Panel High Definition**

1. Poliuretano
2. Piedra

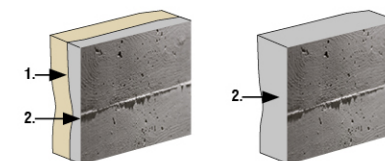







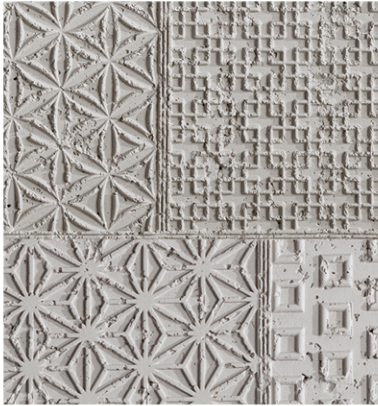

Panel Cemento Geométrico



Panel Cemento Tabla



Panel Cemento Tabla XL



Panel Cemento Vintage



Panel Cemento Hexágono



Panel Cemento Factory



Panel Cemento Bloque



Panel Cemento Tosco



Panel Piedra Encofrado



Panel Piedra Cemento



Panel Piedra Hormigón

# GEOMÉTRICO



E Gris  
EN Grey  
FR Gris  
DE Grau  
I Grigio  
NL Grijs



E Gris  
EN Grey  
FR Gris  
DE Grau  
I Grigio  
NL Grijs



E Gris  
EN Grey  
FR Gris  
DE Grau  
I Grigio  
NL Grijs

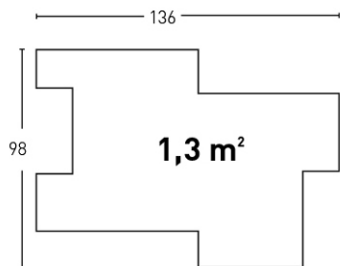
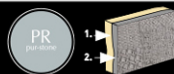

COD.



PR-950-1	● MSA-10	● PTX-64		KIT-4 o KIT-5	7-8		
PR-950-2	● MSA-10	● PTX-64		KIT-4 o KIT-5	7-8		
PR-950-3	● MSA-10	● PTX-64		KIT-4 o KIT-5	7-8		

\* Necesario - Necessary - Nécessaire - Erforderlich - Necessario - Noodzakelijk

\* Consultar fecha de entrega



## GEOMETRICO Gama de Colores



**950-1**

**E** Gris  
**EN** Grey  
**FR** Gris  
**DE** Grau  
**I** Grigio  
**NL** Grijs



**950-2**

**E** Gris  
**EN** Grey  
**FR** Gris  
**DE** Grau  
**I** Grigio  
**NL** Grijs



**950-3**

**E** Gris  
**EN** Grey  
**FR** Gris  
**DE** Grau  
**I** Grigio  
**NL** Grijs

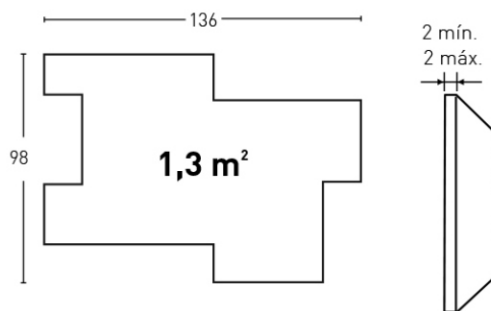

MODELO PANEL CEMENTO TABLA

FICHA TÉCNICA

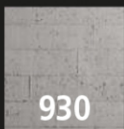

- E** Tabla
- EN** Table
- FR** Planche
- DE** Brett
- I** Tavola
- NL** Tafel

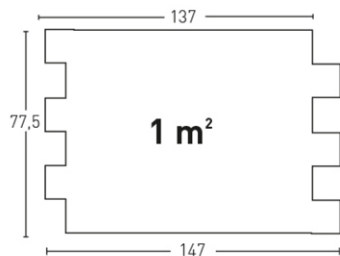
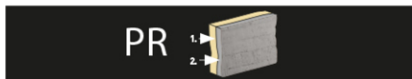

COD.										
PR-930	 MSA-10	 PTX-64-400	KIT-4 o KIT-5			7-8			4	48

\* Necesario - Necessary - Nécessaire - Erforderlich - Necessario - Noodzakelijk



# TABLA Gama de Colores



**930**

- E** Gris
- EN** Grey
- FR** Gris
- DE** Grau
- I** Grigio
- NL** Grijs

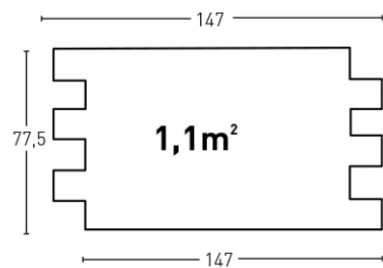

# TABLA XL

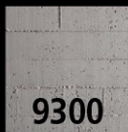

- E** Gris
- EN** Grey
- FR** Gris
- DE** Grau
- I** Grigio
- NL** Grijs

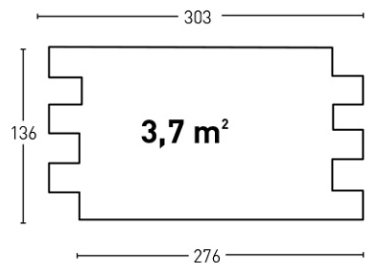
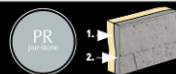

2 mín.  
2 máx.



COD.													
PR-9300	● MSA-10	● PTX-64											

\* Necesario - Necessary - Nécessaire Erforderlich - Necessario - Noodzakelijk



# TABLA XL Gama de Colores



**9300**

- E** Gris
- EN** Grey
- FR** Gris
- DE** Grau
- I** Grigio
- NL** Grijs

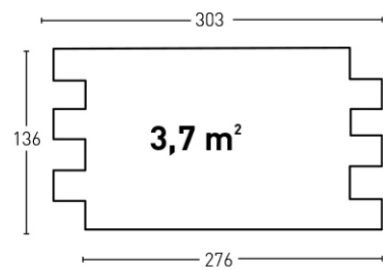

2 mín.  
2 máx.



# VINTAGE

**940-1**

E Gris  
EN Grey  
FR Gris  
DE Grau  
I Grigio  
NL Grijs

**940-2**

E Gris  
EN Grey  
FR Gris  
DE Grau  
I Grigio  
NL Grijs

**940-3**

E Gris  
EN Grey  
FR Gris  
DE Grau  
I Grigio  
NL Grijs

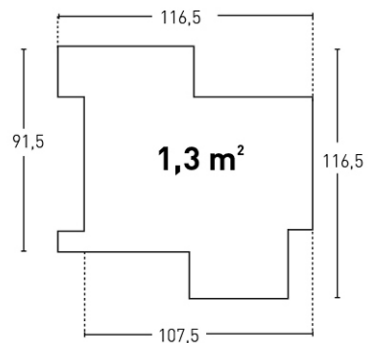
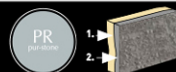

COD.													
PR-940-1	● MSA-10	● PTX-64											
PR-940-2	● MSA-10	● PTX-64											
PR-940-3	● MSA-10	● PTX-64											

\* Necesario - Necessary - Nécessaire - Erforderlich - Necessario - Noodzakelijk

\* Consultar fecha de entrega



## VINTAGE Gama de Colores



**940-1**

**E** Gris  
**EN** Grey  
**FR** Gris  
**DE** Grau  
**I** Grigio  
**NL** Grijs

**940-2**

**E** Gris  
**EN** Grey  
**FR** Gris  
**DE** Grau  
**I** Grigio  
**NL** Grijs

**940-3**

**E** Gris  
**EN** Grey  
**FR** Gris  
**DE** Grau  
**I** Grigio  
**NL** Grijs

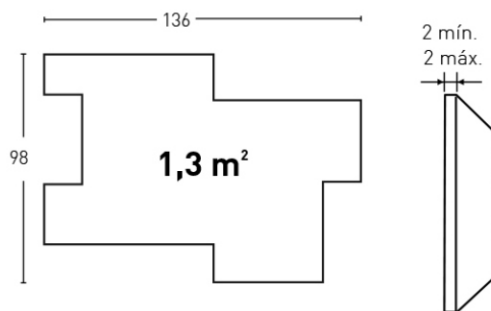

# HEXAGONAL



960-1

- E** Gris
- EN** Grey
- FR** Gris
- DE** Grau
- I** Grigio
- NL** Grijs

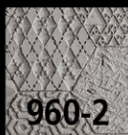

960-2

- E** Gris
- EN** Grey
- FR** Gris
- DE** Grau
- I** Grigio
- NL** Grijs

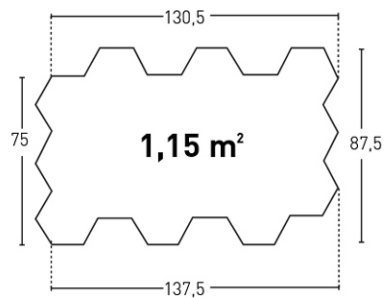
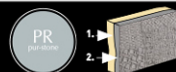

2 mín.  
2 máx.



COD.



PR-960-1	● MSA-10	● PTX-64		KIT-4 o KIT-5	6-7		
PR-960-2	● MSA-10	● PTX-64		KIT-4 o KIT-5	6-7		

\* Necesario - Necessary - Nécessaire Erforderlich - Necessario - Noodzakelijk

\* Consultar fecha de entrega

# HEXAGONAL Gama de Colores



**960-1**

- E** Gris
- EN** Grey
- FR** Gris
- DE** Grau
- I** Grigio
- NL** Grijs

**960-2**

- E** Gris
- EN** Grey
- FR** Gris
- DE** Grau
- I** Grigio
- NL** Grijs

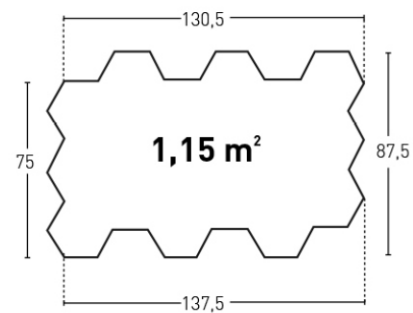

2 mín.  
2 máx.



# FACTORY



- E** Gris
- EN** Grey
- FR** Gris
- DE** Grau
- I** Grigio
- NL** Grijs

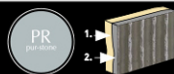

**COD.**



PR-980	● MSA-10	● PTX-64		KIT-4 o KIT-5	14-15		
--------	----------	----------	--	---------------	-------	--	--

\* Necesario - Necessary - Nécessaire - Erforderlich - Necessario - Noodzakelijk

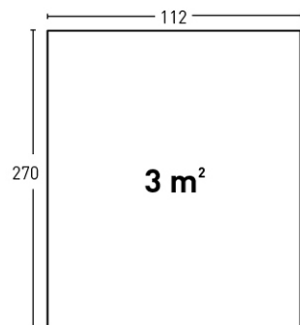

1 mín.  
6 máx.



\* Consultar fecha de entrega



# FACTORY Gama de Colores



**980**

- E** Gris
- EN** Grey
- FR** Gris
- DE** Grau
- I** Grigio
- NL** Grijs

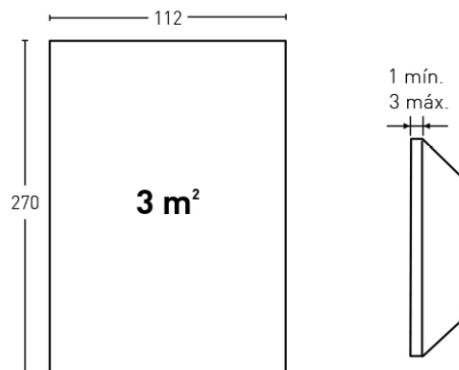

# BLOQUE



- E** Gris
- EN** Grey
- FR** Gris
- DE** Grau
- I** Grigio
- NL** Grijs

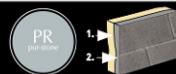

**COD.**



PR-970	● MSA-10	● PTX-64		KIT-4 o KIT-5	14-15		T
--------	----------	----------	--	---------------	-------	--	---

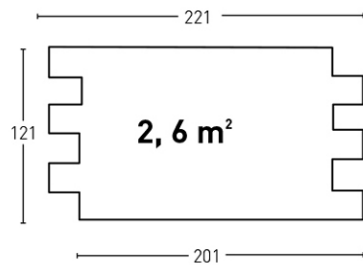

\* Necesario - Necessary - Nécessaire Erforderlich - Necessario - Noodzakelijk

2 mín.  
2 máx.



\* Consultar fecha de entrega

## BLOQUE Gama de Colores



**970**

- E** Gris
- EN** Grey
- FR** Gris
- DE** Grau
- I** Grigio
- NL** Grijs

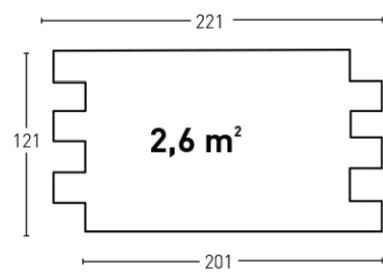

2 mín.  
2 máx.



# TOSCO



910

- E** Gris
- EN** Grey
- FR** Gris
- DE** Grau
- I** Grigio
- NL** Grijs

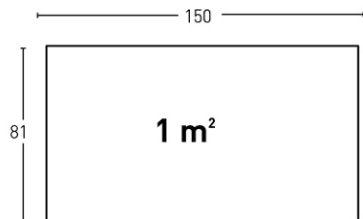
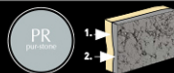

2 mín.  
2 máx.



**COD.**



PR-910	● MSA-10	● PTX-64		KIT-4 o KIT-5	6-7		
--------	----------	----------	--	---------------	-----	--	--

\* Necesario - Necessary - Nécessaire - Erforderlich - Necessario - Noodzakelijk

\* Consultar fecha de entrega





**910**

- E** Gris
- EN** Grey
- FR** Gris
- DE** Grau
- I** Grigio
- NL** Grijs

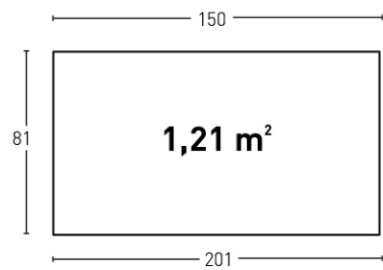

2 mín.  
2 máx.



# ENCOFRADO

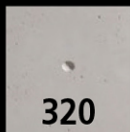

E Gris  
EN Grey  
FR Gris  
DE Grau  
I Grigio  
NL Grijs

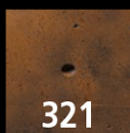

E Oxido  
EN Rusty  
FR Oxi de  
DE Rost  
I Ossido  
NL Roest



E Antracita  
EN Anthracite  
FR Anthracite  
DE Anthrazit  
I Antracite  
NL Zwart

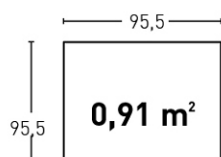
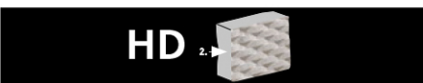
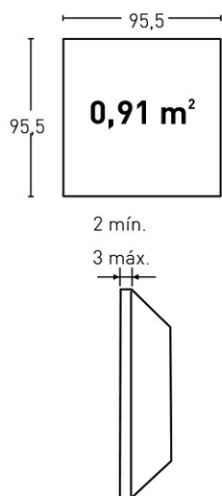
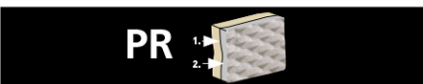

COD.	MSA-10	PTX-01	PTE-22	KIT-4 o KIT-5	KG	Barcode	Box	Panel
PR-920	●	●	●	KIT-4 o KIT-5	5-6	8435068949206	6	72
PR-921	●	●	●	KIT-4 o KIT-5	5-6	8435068949213	6	72
PR-922	●	●	●	KIT-4 o KIT-5	5-6	8435068949220	6	72

\* Necesario - Necessary - N cessaire - Erforderlich - Necessario - Noodzakelijk



COD.	MSA-10	PTX-01	PTE-22	KIT-4 o KIT-5	KG	Barcode	Box	Panel
HD-920	●	●	●	KIT-4 o KIT-5	24	8435068919209	25	25
HD-921	●	●	●	KIT-4 o KIT-5	24	8435068919216	25	25
HD-922	●	●	●	KIT-4 o KIT-5	24	8435068919223	25	25

\* Necesario - Necessary - N cessaire - Erforderlich - Necessario - Noodzakelijk

## ENCOFRADO Gama de Colores



**920**

**E** Gris  
**EN** Grey  
**FR** Gris  
**DE** Grau  
**I** Grigio  
**NL** Grijs



**921**

**E** Oxido  
**EN** Rusty  
**FR** Oxidé  
**DE** Rost  
**I** Ossido  
**NL** Roest



**922**

**E** Antracita  
**EN** Anthracite  
**FR** Anthracite  
**DE** Anthrazit  
**I** Antracite  
**NL** Zwart

**PR**



**HD**

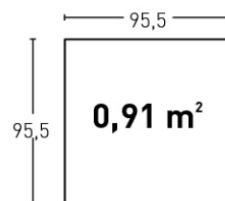

2 mín.  
3 máx.



## PANEL DE PIEDRA - STONE PANEL CEMENTO

320	E Gris EN Grey FR Gris DE Grau I Grigio NL Grijs
321	E Oxido EN Rusty FR Oxidé DE Rost I Ossido NL Roest
322	E Antracita EN Anthracite FR Anthracite DE Anthrazit I Antracite NL Zwart

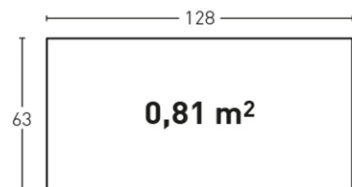
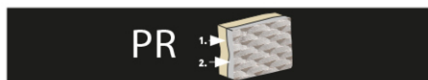

2 min.  
2 max.

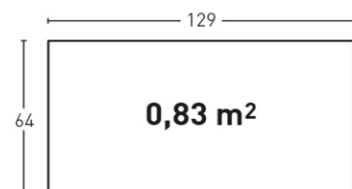

2 min.  
2 max.



COD.	MSA-10	PTX-01	PTE-22	KIT-4 o KIT-5	KG	Barcode	Box	Pallet
PR-320	●	●	●	KIT-4 o KIT-5	5-6	8435068943204	6	72
PR-321	●	●	●	KIT-4 o KIT-5	5-6	8435068943211	6	72
PR-322	●	●		KIT-4 o KIT-5	5-6	8435068943228	6	72

\* Necesario - Necessary - Nécessaire - Erforderlich - Necessario - Noodzakelijk



COD.	MSA-10	PTX-01	PTE-22	KIT-4 o KIT-5	KG	Barcode	Box	Pallet
HD-320	●	●	●	KIT-4 o KIT-5	24	8435068913204	25	25
HD-321	●	●	●	KIT-4 o KIT-5	24	8435068913211	25	25
HD-322	●	●		KIT-4 o KIT-5	24	8435068913228	25	25

\* Necesario - Necessary - Nécessaire - Erforderlich - Necessario - Noodzakelijk



# CEMENTO Gama de Cores



320

- E Gris
- EN Grey
- FR Gris
- DE Grau
- I Grigio
- NL Grijs



321

- E Oxido
- EN Rusty
- FR Oxidé
- DE Rost
- I Ossido
- NL Roest



322

- E Antracita
- EN Anthracite
- FR Anthracite
- DE Anthrazit
- I Antracite
- NL Zwart

PR 

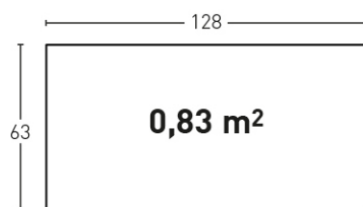

2 min.  
2 max.



HD 

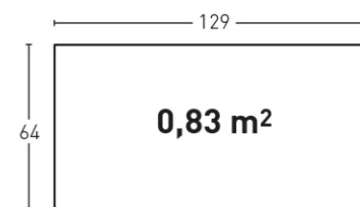

2 min.  
2 max.



## PANEL DE PIEDRA - STONE PANEL HORMIGON



E Gris  
EN Grey  
FR Gris  
DE Grau  
I Grigio  
NL Grijs



E Oxido  
EN Rusty  
FR Oxydé  
DE Rost  
I Ossido  
NL Roest



E Antracita  
EN Anthracite  
FR Anthracite  
DE Anthrazit  
I Antracite  
NL Zwart

PR

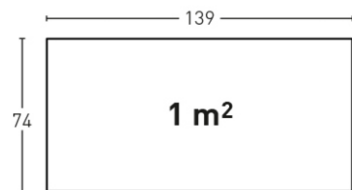
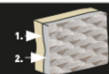

2 min.  
2 max.



HD

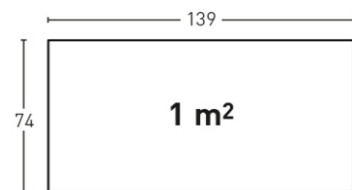
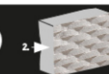

1 min.  
1 max.



COD.



PR-326	● MSA-10	● PTX-01	● PTE-22	KIT-4 o KIT-5	5-6	8435068943204	6	72
PR-327	● MSA-60	● PTX-24	● PTE-28	KIT-4 o KIT-5	5-6	8435068943211	6	72
PR-325	● MSA-60	● PTX-19		KIT-4 o KIT-5	5-6	8435068943228	6	72

\* Necesario - Necessary - Nécessaire - Erforderlich - Necessario - Noodzakelijk

COD.



HD-326	● MSA-10	● PTX-01	● PTE-22	KIT-4 o KIT-5	25	8435068913269	25	25
HD-327	● MSA-60	● PTX-24	● PTE-28	KIT-4 o KIT-5	25	8435068913276	25	25
HD-325	● MSA-60	● PTX-19		KIT-4 o KIT-5	25	8435068913252	25	25

\* Necesario - Necessary - Nécessaire - Erforderlich - Necessario - Noodzakelijk

# HORMIGON Gama de Colores



326

- E Gris
- EN Grey
- FR Gris
- DE Grau
- I Grigio
- NL Grijs

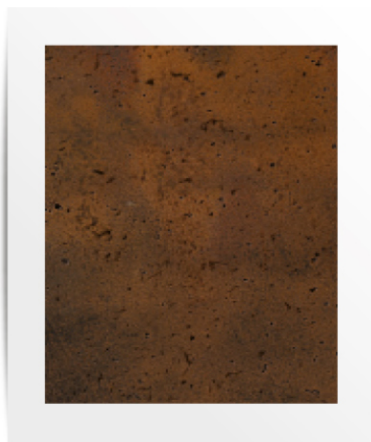

327

- E Oxido
- EN Rusty
- FR Oxidé
- DE Rost
- I Ossido
- NL Roest



325

- E Antracita
- EN Anthracite
- FR Anthracite
- DE Anthrazit
- I Antracite
- NL Zwart

PR 

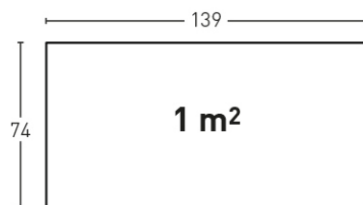

2 min.  
2 max.



HD 

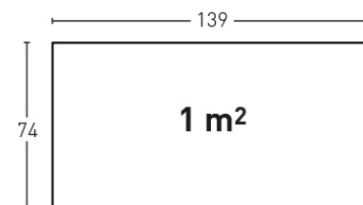

1 min.  
1 max.



## PanelPiedra®

- E** Panel Piedra® se reserva el derecho a cambiar los modelos, colores, tamaños, envases y cajas sin previo aviso. Todos los pesos y dimensiones mencionadas son en cm y se muestran con la mayor precisión posible, pero pueden diferir hasta 2% por la expansión y la contracción durante la producción. Las fotografías de este Catálogo se crean en lugares del proyecto y en estudios, algunos incluso podrían ser animaciones. Las diferencias en la exposición de la luz y la impresión en papel pueden causar que los productos y los colores se vea diferente que en la realidad.
- I** Panel Piedra si riserva il diritto di modificare senza preavviso modelli, dimensioni, confezione e imballaggio senza alcun preavviso. Tutti i pesi e le misure sono riportate in centimetri e con la maggiore precisione possibile, tuttavia però possono differire di un 2% a causa della espansione e contrazione avvenute nei prodotti durante le fasi di fabbricazione. Tutte le fotografie di questo Catalogo sono scattate in loco o in studio. Alcune di esse potrebbero essere ricostruzioni fotografiche. Le differenti esposizioni alla luce e la stampa su carta potrebbero causare delle differenze nei prodotti e nei colori rispetto alla realtà. Non verranno pertanto accettati reclami con tali motivazioni.
- EN** We reserve the right to change models, colours, sizes and packaging without prior notice. All mentioned weights and dimensions are in cm and displayed as accurately as possible but can differ up to 2% by expansion and shrinkage during production. The photographs in this brochure are created on project locations and in studios, some even might be animations. Differences in exposure and printing on paper may cause products and colours looking different than in reality.
- FR** Nous nous réservons le droit de modifier les modèles, de couleurs, de tailles et d'emballage sans avis préalable. Tous les poids et les dimensions mentionnés sont en cm et affichent aussi exactement que possible mais peuvent varier de 2 % par l'expansion et la contraction pendant la production. Les photos dans cette brochure sont créées en studio, sur des projets déjà réalisés ou sont des animations. Ils peuvent provoquer des différences de teinte et de l'impression. Sur papier les modèles et les teintes peuvent sembler différente que dans la réalité.
- DE** Wir behalten uns das Recht, Modelle, Farben, Größen und Verpackungen ohne vorherige Ankündigung zu ändern. Alle genannten Gewichte und Maße sind in cm und so genau wie möglich angezeigt, können aber bis zu 2 % durch Expansion und Schrumpfung während der Produktion abweichen. Die Fotografien in dieser Broschüre werden auf Standorte, Studios und als Computer Animation erstellt. Unterschiede in Licht und Druck auf Papier können dazu führen, dass Farben und Produkte anders erscheinen als in Wirklichkeit.
- NL** Wij behouden ons het recht voor om modellen, kleuren, afmetingen en verpakkingen te wijzigen zonder voorafgaande melding. Alle genoemde afmetingen en gewichten zijn in cm en zo nauwkeurig mogelijk weergegeven, maar kunnen door uitzetting en krimp tijdens productie tot 2% afwijken. De foto's in deze brochure zijn gemaakt op projectlocaties, in studio's en als computeranimatie. Door verschillen in belichting en druk op papier kunnen kleuren en producten anders lijken dan in werkelijkheid.